

**PHILIPPINE BIDDING DOCUMENTS**

**2<sup>ND</sup> PUBLIC BIDDING  
FOR THE  
PROCUREMENT OF  
CORRUGATED CARTON  
for SAN PABLO  
MANUFACTURING  
CORPORATION**

SPMC-2023-009B

Government of the Republic of the Philippines

**Sixth Edition  
July 2020**

## Preface

These Philippine Bidding Documents (PBDs) for the procurement of Goods through Competitive Bidding have been prepared by the Government of the Philippines for use by any branch, constitutional commission or office, agency, department, bureau, office, or instrumentality of the Government of the Philippines, National Government Agencies, including Government-Owned and/or Controlled Corporations, Government Financing Institutions, State Universities and Colleges, and Local Government Unit. The procedures and practices presented in this document have been developed through broad experience, and are for mandatory use in projects that are financed in whole or in part by the Government of the Philippines or any foreign government/foreign or international financing institution in accordance with the provisions of the 2016 revised Implementing Rules and Regulations of Republic Act No. 9184.

The Bidding Documents shall clearly and adequately define, among others: (i) the objectives, scope, and expected outputs and/or results of the proposed contract or Framework Agreement, as the case may be; (ii) the eligibility requirements of Bidders; (iii) the expected contract or Framework Agreement duration, the estimated quantity in the case of procurement of goods, delivery schedule and/or time frame; and (iv) the obligations, duties, and/or functions of the winning bidder.

Care should be taken to check the relevance of the provisions of the PBDs against the requirements of the specific Goods to be procured. If duplication of a subject is inevitable in other sections of the document prepared by the Procuring Entity, care must be exercised to avoid contradictions between clauses dealing with the same matter.

Moreover, each section is prepared with notes intended only as information for the Procuring Entity or the person drafting the Bidding Documents. They shall not be included in the final documents. The following general directions should be observed when using the documents:

- a. All the documents listed in the Table of Contents are normally required for the procurement of Goods. However, they should be adapted as necessary to the circumstances of the particular Procurement Project.
- b. Specific details, such as the “*name of the Procuring Entity*” and “*address for bid submission*,” should be furnished in the Instructions to Bidders, Bid Data Sheet, and Special Conditions of Contract. The final documents should contain neither blank spaces nor options.
- c. This Preface and the footnotes or notes in italics included in the Invitation to Bid, Bid Data Sheet, General Conditions of Contract, Special Conditions of Contract, Schedule of Requirements, and Specifications are not part of the text of the final document, although they contain instructions that the Procuring Entity should strictly follow.

- d. The cover should be modified as required to identify the Bidding Documents as to the Procurement Project, Project Identification Number, and Procuring Entity, in addition to the date of issue.
- e. Modifications for specific Procurement Project details should be provided in the Special Conditions of Contract as amendments to the Conditions of Contract.

For easy completion, whenever reference has to be made to specific clauses in the Bid Data Sheet or Special Conditions of Contract, these terms shall be printed in bold typeface on Sections I (Instructions to Bidders) and III (General Conditions of Contract), respectively.

- f. For guidelines on the use of Bidding Forms and the procurement of Foreign-Assisted Projects, these will be covered by a separate issuance of the Government Procurement Policy Board.

# Table of Contents

|  |              |
|--|--------------|
| <b>Glossary of Acronyms, Terms, and Abbreviations .....</b>                  | <b>5-7</b>   |
| <b>Section I. Invitation to Bid.....</b>                                     | <b>8-11</b>  |
| <b>Section II. Instructions to Bidders.....</b>                              | <b>12-19</b> |
| 1. Scope of Bid .....  | 13           |
| 2. Funding Information.....  | 13           |
| 3. Bidding Requirements .....  | 14           |
| 4. Corrupt, Fraudulent, Collusive, and Coercive Practices.....               | 14           |
| 5. Eligible Bidders.....   | 14           |
| 6. Origin of Goods .....   | 14           |
| 7. Subcontracts .....  | 15           |
| 8. Pre-Bid Conference .....  | 15           |
| 9. Clarification and Amendment of Bidding Documents .....                    | 15           |
| 10. Documents comprising the Bid: Eligibility and Technical Components ..... | 15           |
| 11. Documents comprising the Bid: Financial Component .....                  | 16           |
| 12. Bid Prices .....   | 16           |
| 13. Bid and Payment Currencies .....   | 16           |
| 14. Bid Security .....   | 17           |
| 15. Sealing and Marking of Bids .....  | 17           |
| 16. Deadline for Submission of Bids .....                                    | 17           |
| 17. Opening and Preliminary Examination of Bids .....                        | 17           |
| 18. Domestic Preference .....  | 18           |
| 19. Detailed Evaluation and Comparison of Bids .....                         | 18           |
| 20. Post-Qualification .....   | 18           |
| 21. Signing of the Contract .....  | 19           |
| <b>Section III. Bid Data Sheet .....</b>                                     | <b>20-23</b> |
| <b>Section IV. General Conditions of Contract .....</b>                      | <b>24-26</b> |
| 1. Scope of Contract .....   | 25           |
| 2. Advance Payment and Terms of Payment .....                                | 25           |
| 3. Performance Security .....  | 25           |
| 4. Inspection and Tests .....  | 25           |
| 5. Warranty .....  | 26           |
| 6. Liabilities of the Supplier .....   | 26           |
| <b>Section V. Special Conditions of Contract .....</b>                       | <b>27-31</b> |
| <b>Section VI. Schedule of Requirements .....</b>                            | <b>32</b>    |
| <b>Section VII. Technical Specifications .....</b>                           | <b>33-37</b> |
| <b>Section VIII. Checklist of Technical and Financial Documents .....</b>    | <b>38-40</b> |
| <b>Section IX Bidding Forms</b>  |              |

|   |           |
|---|-----------|
| 1. Bid Securing Declaration.....  | Annex "A" |
| 2. Omnibus Sworn Statement.....   | Annex "B" |
| 3. Financial Bid Form.....  | Annex "C" |
| 4. Bid Price Schedule .....   | Annex "D" |
| 5. Statement of Ongoing and Awarded but not yet started Contracts .....                     | Annex "E" |
| 6. Statement of Single Largest Completed Contract similar to<br>the Contract to be Bid..... | Annex "F" |
| 7. Contract Agreement.....  | Annex "G" |
| 8. NFCC Computation .....   | Annex "H" |
| 9. Affidavit of Compliance with Technical Specifications .....                              | Annex "I" |

**Section X. Appendix**

|  |           |
|--|-----------|
| Illustration of Sealing and Marking of Bids..... | Annex "J" |
|--|-----------|

# *Glossary of Acronyms, Terms, and Abbreviations*

**ABC** – Approved Budget for the Contract.

**BAC** – Bids and Awards Committee.

**Bid** – A signed offer or proposal to undertake a contract submitted by a bidder in response to and in consonance with the requirements of the bidding documents. Also referred to as *Proposal* and *Tender*. (2016 revised IRR, Section 5[c])

**Bidder** – Refers to a contractor, manufacturer, supplier, distributor and/or consultant who submits a bid in response to the requirements of the Bidding Documents. (2016 revised IRR, Section 5[d])

**Bidding Documents** – The documents issued by the Procuring Entity as the bases for bids, furnishing all information necessary for a prospective bidder to prepare a bid for the Goods, Infrastructure Projects, and/or Consulting Services required by the Procuring Entity. (2016 revised IRR, Section 5[e])

**BIR** – Bureau of Internal Revenue.

**BSP** – Bangko Sentral ng Pilipinas.

**Consulting Services** – Refer to services for Infrastructure Projects and other types of projects or activities of the GOP requiring adequate external technical and professional expertise that are beyond the capability and/or capacity of the GOP to undertake such as, but not limited to: (i) advisory and review services; (ii) pre-investment or feasibility studies; (iii) design; (iv) construction supervision; (v) management and related services; and (vi) other technical services or special studies. (2016 revised IRR, Section 5[i])

**CDA** - Cooperative Development Authority.

**Contract** – Refers to the agreement entered into between the Procuring Entity and the Supplier or Manufacturer or Distributor or Service Provider for procurement of Goods and Services; Contractor for Procurement of Infrastructure Projects; or Consultant or Consulting Firm for Procurement of Consulting Services; as the case may be, as recorded in the Contract Form signed by the parties, including all attachments and appendices thereto and all documents incorporated by reference therein.

**CIF** – Cost Insurance and Freight.

**CIP** – Carriage and Insurance Paid.

**CPI** – Consumer Price Index.

**DDP** – Refers to the quoted price of the Goods, which means “delivered duty paid.”

**DTI** – Department of Trade and Industry.

**EXW** – Ex works.

**FCA** – “Free Carrier” shipping point.

**FOB** – “Free on Board” shipping point.

**Foreign-funded Procurement or Foreign-Assisted Project**– Refers to procurement whose funding source is from a foreign government, foreign or international financing institution as specified in the Treaty or International or Executive Agreement. (2016 revised IRR, Section 5[b]).

**Framework Agreement** – Refers to a written agreement between a procuring entity and a supplier or service provider that identifies the terms and conditions, under which specific purchases, otherwise known as “Call-Offs,” are made for the duration of the agreement. It is in the nature of an option contract between the procuring entity and the bidder(s) granting the procuring entity the option to either place an order for any of the goods or services identified in the Framework Agreement List or not buy at all, within a minimum period of one (1) year to a maximum period of three (3) years. (GPPB Resolution No. 27-2019)

**GFI** – Government Financial Institution.

**GOCC** – Government-owned and/or –controlled corporation.

**Goods** – Refer to all items, supplies, materials and general support services, except Consulting Services and Infrastructure Projects, which may be needed in the transaction of public businesses or in the pursuit of any government undertaking, project or activity, whether in the nature of equipment, furniture, stationery, materials for construction, or personal property of any kind, including non-personal or contractual services such as the repair and maintenance of equipment and furniture, as well as trucking, hauling, janitorial, security, and related or analogous services, as well as procurement of materials and supplies provided by the Procuring Entity for such services. The term “related” or “analogous services” shall include, but is not limited to, lease or purchase of office space, media advertisements, health maintenance services, and other services essential to the operation of the Procuring Entity. (2016 revised IRR, Section 5[r])

**GOP** – Government of the Philippines.

**GPPB** – Government Procurement Policy Board.

**INCOTERMS** – International Commercial Terms.

**Infrastructure Projects** – Include the construction, improvement, rehabilitation, demolition, repair, restoration or maintenance of roads and bridges, railways, airports, seaports, communication facilities, civil works components of information technology projects, irrigation, flood control and drainage, water supply, sanitation, sewerage and solid waste management systems, shore protection, energy/power and electrification facilities, national



buildings, school buildings, hospital buildings, and other related construction projects of the government. Also referred to as *civil works or works*. (2016 revised IRR, Section 5[u])

**LGUs** – Local Government Units.

**NFCC** – Net Financial Contracting Capacity.

**NGA** – National Government Agency.

**PhilGEPS** - Philippine Government Electronic Procurement System.

**Procurement Project** – refers to a specific or identified procurement covering goods, infrastructure project or consulting services. A Procurement Project shall be described, detailed, and scheduled in the Project Procurement Management Plan prepared by the agency which shall be consolidated in the procuring entity's Annual Procurement Plan. (GPPB Circular No. 06-2019 dated 17 July 2019)

**PSA** – Philippine Statistics Authority.

**SEC** – Securities and Exchange Commission.

**SLCC** – Single Largest Completed Contract.

**Supplier** – refers to a citizen, or any corporate body or commercial company duly organized and registered under the laws where it is established, habitually established in business and engaged in the manufacture or sale of the merchandise or performance of the general services covered by his bid. (Item 3.8 of GPPB Resolution No. 13-2019, dated 23 May 2019). Supplier as used in these Bidding Documents may likewise refer to a distributor, manufacturer, contractor, or consultant.

**UN** – United Nations.

## ***Section I. Invitation to Bid***

### **Notes on the Invitation to Bid**

The Invitation to Bid (IB) provides information that enables potential Bidders to decide whether to participate in the procurement at hand. The IB shall be posted in accordance with Section 21.2 of the 2016 revised IRR of RA No. 9184.

Apart from the essential items listed in the Bidding Documents, the IB should also indicate the following:

- a. The date of availability of the Bidding Documents, which shall be from the time the IB is first advertised/posted until the deadline for the submission and receipt of bids;
- b. The place where the Bidding Documents may be acquired or the website where it may be downloaded;
- c. The deadline for the submission and receipt of bids; and
- d. Any important bid evaluation criteria (*e.g.*, the application of a margin of preference in bid evaluation).

The IB should be incorporated in the Bidding Documents. The information contained in the IB must conform to the Bidding Documents and in particular to the relevant information in the Bid Data Sheet.



Republic of the Philippines  
Office of the President

Coconut Industry Investment Fund Oil Mills Group (CIIF OMG)  
16F SEC Headquarters (formerly UCPB Building), Makati Avenue, Makati City



Invitation to Bid No. **SPMC-2023-009B**  
Date of Posting: July 1, 2023

**INVITATION TO BID**  
**For the 2<sup>nd</sup> Public Bidding for the Procurement**  
**of CORRUGATED CARTON for SAN PABLO**  
**MANUFACTURING CORPORATION**

- The Coconut Industry Investment Fund - San Pablo Manufacturing Corporation (SPMC), through the *2023 Corporate Budget* intends to apply the sum of **Four Million Five Hundred Fifty-Eight Thousand Seven Hundred Fifty Pesos and 01/100 (P4,558,750.01)** inclusive of all applicable government taxes being the ABC to payments under the contract for the ***CORRUGATED CARTON for SAN PABLO MANUFACTURING CORPORATION***. Bids received in excess of the ABC shall be automatically rejected at bid opening.

The Coconut Industry Investment Fund - San Pablo Manufacturing Corporation (SPMC), through the *2023 Corporate Budget* intends to apply the sum of:

| Lots  | Particulars / Description                      | Quantity       | ABC                    |
|-------|--|----------------|------------------------|
| Lot 1 | CORR. CARTON FOR MINOLA PE CONTAINERS          |                |                        |
|       | 1.. CORR. CARTON FOR MINOLA PE 4 X 3.5 LITERS  | 1. 39,686 sets | Item 1 - P1,093,746.16 |
|       | 2. CORR. CARTON FOR MINOLA PE 10 X 1.75 LITERS | 2. 34,094 sets | Item 2 - P1,293,867.30 |
|       |  |                | Total - P2,387,613.46  |

|                  |  |               |                         |
|------------------|--|---------------|-------------------------|
| Lot 2            | CORRUGATED CARTON FOR SHORTENING PRODUCTS      |               |                         |
|                  | 1. CORR. CARTON BOXES FOR VEGETABLE SHORTENING | 1. 61,815 pcs | Item 1 - P 1,978,698.15 |
|                  | 2. CORR. CARTON FOR BM 20K AND BOS 20K         | 2. 5,680 pcs  | Item 2 - P 192,438.40   |
|                  |  |               | Total - P 2,171,136.55  |
| <b>Total ABC</b> |  |               | <b>P 4,558,750.01</b>   |

2. The *Coconut Industry Investment Fund - San Pablo Manufacturing Corporation (SPMC)* now invites bids for the above Procurement Project. Delivery of the Goods is required by September 8, 2023. Bidders should have completed, within *Five (5) years* from the date of submission and receipt of bids, a contract similar to the Project. The description of an eligible bidder is contained in the Bidding Documents, particularly, in Section II (Instructions to Bidders).
3. Bidding will be conducted through open competitive bidding procedures using a non-discretionary “*pass/fail*” criterion as specified in the 2016 revised Implementing Rules and Regulations (IRR) of Republic Act (RA) No. 9184.
  - a. Bidding is open to all interested bidders, whether local or foreign, subject to the conditions for eligibility provided in the 2016 revised IRR of RA No. 9184.
4. Prospective Bidders may obtain further information from *Coconut Industry Investment Fund - San Pablo Manufacturing Corporation (SPMC)* and inspect the Bidding Documents at the address given below during *9:00am to 5:00pm*.
5. A complete set of Bidding Documents may be acquired by interested Bidders on *July 1, 2023* from the given address and website(s) below *and upon payment of the applicable fee for the Bidding Documents, pursuant to the latest Guidelines issued by the GPPB, in the amount of P5,000.00*. The Procuring Entity shall allow the bidder to present its proof of payment for the fees *to be presented in person, by facsimile, or through electronic means*.
6. The *Coconut Industry Investment Fund - San Pablo Manufacturing Corporation (SPMC)* will hold a Pre-Bid Conference<sup>1</sup> on *July 10, 2023, 2:00PM* at 16F Securities and Exchange Headquarters (formerly UCPB Bldg.) Makati Avenue, Makati City and/or through video conferencing or webcasting *via Zoom Application (Meeting ID: 870 0550 0441; Password: 513074)*, which shall be open to prospective bidders.
7. Bids must be duly received by the BAC Secretariat through manual submission at the office address indicated below on or before July 25, 2023 at 10:00AM. Late bids shall not be accepted.

<sup>1</sup> May be deleted in case the ABC is less than One Million Pesos (PhP1,000,000) where the Procuring Entity may not hold a Pre-Bid Conference.

8. All Bids must be accompanied by a bid security in any of the acceptable forms and in the amount stated in **ITB** Clause 14.
9. Bid opening shall be on *July 25, 2023, 11:00AM* through hybrid set-up. Bidders may be physically present at CIIF-OMG at the given address below and/or through video conferencing or webcasting *via Zoom Application (Meeting ID: 829 3151 7784)*. Bids will be opened in the presence of the bidders' representatives who choose to attend the activity.
10. The *Coconut Industry Investment Fund - San Pablo Manufacturing Corporation (SPMC)* reserves the right to reject any and all bids, declare a failure of bidding, or not award the contract at any time prior to contract award in accordance with Sections 35.6 and 41 of the 2016 revised IRR of RA No. 9184, without thereby incurring any liability to the affected bidder or bidders.
11. For further information, please refer to:  
  
Ms. Angelita G. Rapada  
BAC Secretariat  
16th Floor, Securities and Exchange Commission Headquarters,  
Makati Avenue, Makati City  
Telephone Number: (632) 8892-2927  
Email Address: arapada@ciif.ph
12. You may visit the following websites:  
For downloading of Bidding Documents: *www.ciif.ph*

Originally Signed

*AL MATTHEW P. UMALI*  
*Chairperson, Bids and Awards Committee I*

## ***Section II. Instructions to Bidders***

### **Notes on the Instructions to Bidders**

This Section on the Instruction to Bidders (ITB) provides the information necessary for bidders to prepare responsive bids, in accordance with the requirements of the Procuring Entity. It also provides information on bid submission, eligibility check, opening and evaluation of bids, post-qualification, and on the award of contract.

## 1. Scope of Bid

The Procuring Entity, **Coconut Industry Investment Fund - San Pablo Manufacturing Corporation (SPMC)** wishes to receive Bids for the **CORRUGATED CARTON for SAN PABLO MANUFACTURING CORPORATION**, with identification number **SPMC-2023-009B**.

The Procurement Project (referred to herein as “Project”) is composed of:

| Lots             | Particulars / Description                      | Quantity       | ABC                     |
|------------------|--|----------------|-------------------------|
| Lot 1            | CORR. CARTON FOR MINOLA PE CONTAINERS          |                |                         |
|                  | 1.. CORR. CARTON FOR MINOLA PE 4 X 3.5 LITERS  | 1. 39,686 sets | Item 1 - P1,093,746.16  |
|                  | 2. CORR. CARTON FOR MINOLA PE 10 X 1.75 LITERS | 2. 34,094 sets | Item 2 - P1,293,867.30  |
|                  |  |                | Total - P2,387,613.46   |
| Lot 2            | CORRUGATED CARTON FOR SHORTENING PRODUCTS      |                |                         |
|                  | 1. CORR. CARTON BOXES FOR VEGETABLE SHORTENING | 1. 61,815 pcs  | Item 1 - P 1,978,698.15 |
|                  | 2. CORR. CARTON FOR BM20K AND BOS 20K          | 2. 5,680 pcs   | Item 2 - P 192,438.40   |
|                  |  |                | Total - P 2,171,136.55  |
| <b>Total ABC</b> |  |                | <b>P 4,558,750.01</b>   |

the details of which are described in Section VII (Technical Specifications).

## 2. Funding Information

2.1. The GOP through the source of funding as indicated below for **2023 Corporate Budget** in the amount of **P4,558,750.01**.

2.2. The source of funding is:

- a. GOCC and GFIs, the proposed Corporate Operating Budget.

### 3. Bidding Requirements

The Bidding for the Project shall be governed by all the provisions of RA No. 9184 and its 2016 revised IRR, including its Generic Procurement Manuals and associated policies, rules and regulations as the primary source thereof, while the herein clauses shall serve as the secondary source thereof.

Any amendments made to the IRR and other GPPB issuances shall be applicable only to the ongoing posting, advertisement, or **IB** by the BAC through the issuance of a supplemental or bid bulletin.

The Bidder, by the act of submitting its Bid, shall be deemed to have verified and accepted the general requirements of this Project, including other factors that may affect the cost, duration and execution or implementation of the contract, project, or work and examine all instructions, forms, terms, and project requirements in the Bidding Documents.

### 4. Corrupt, Fraudulent, Collusive, and Coercive Practices

The Procuring Entity, as well as the Bidders and Suppliers, shall observe the highest standard of ethics during the procurement and execution of the contract. They or through an agent shall not engage in corrupt, fraudulent, collusive, coercive, and obstructive practices defined under Annex "I" of the 2016 revised IRR of RA No. 9184 or other integrity violations in competing for the Project.

### 5. Eligible Bidders

- 5.1. Only Bids of Bidders found to be legally, technically, and financially capable will be evaluated.
- 5.2. Foreign ownership limited to those allowed under the rules may participate in this Project.
- 5.3. Pursuant to Section 23.4.1.3 of the 2016 revised IRR of RA No.9184, the Bidder shall have an SLCC that is at least one (1) contract similar to the Project the value of which, adjusted to current prices using the PSA's CPI, must be at least equivalent to:

***The Bidder must have completed a single contract that is similar to this Project, equivalent to at least twenty-five percent (25%) of the ABC. (Expendable Supplies and Services)***

- 5.4. The Bidders shall comply with the eligibility criteria under Section 23.4.1 of the 2016 IRR of RA No. 9184.

### 6. Origin of Goods

There is no restriction on the origin of goods other than those prohibited by a decision of the UN Security Council taken under Chapter VII of the Charter of the UN, subject to Domestic Preference requirements under **ITB** Clause 18.



## 7. Subcontracts

- 7.1. The Bidder may subcontract portions of the Project to the extent allowed by the Procuring Entity as stated herein, but in no case more than twenty percent (20%) of the Project.

The Procuring Entity has prescribed that:

- a. Subcontracting is not allowed.
- 7.2. Subcontracting of any portion of the Project does not relieve the Supplier of any liability or obligation under the Contract. The Supplier will be responsible for the acts, defaults, and negligence of any subcontractor, its agents, servants, or workmen as fully as if these were the Supplier's own acts, defaults, or negligence, or those of its agents, servants, or workmen.

## 8. Pre-Bid Conference

The Procuring Entity will hold a pre-bid conference for this Project on the specified date and time and either at its physical address at 16<sup>th</sup> floor, Securities and Exchange Commission (formerly UCPB Building), Makati Avenue, Makati City and/or through videoconferencing/webcasting as indicated in paragraph 6 of the **IB**.

## 9. Clarification and Amendment of Bidding Documents

Prospective bidders may request for clarification on and/or interpretation of any part of the Bidding Documents. Such requests must be in writing and received by the Procuring Entity, either at its given address or through electronic mail indicated in the **IB**, at least ten (10) calendar days before the deadline set for the submission and receipt of Bids.

## 10. Documents comprising the Bid: Eligibility and Technical Components

- 10.1. The first envelope shall contain the eligibility and technical documents of the Bid as specified in **Section VIII (Checklist of Technical and Financial Documents)**.
- 10.2. The Bidder's SLCC as indicated in **ITB** Clause 5.3 should have been completed within **Five (5) years** prior to the deadline for the submission and receipt of bids.
- 10.3. If the eligibility requirements or statements, the bids, and all other documents for submission to the BAC are in foreign language other than English, it must be accompanied by a translation in English, which shall be authenticated by the appropriate Philippine foreign service establishment, post, or the equivalent office having jurisdiction over the foreign bidder's affairs in the Philippines. Similar to the required authentication above, for Contracting Parties to the Apostille Convention, only the translated documents shall be authenticated through an apostille pursuant to GPPB Resolution No. 13-2019 dated 23 May 2019. The English translation shall govern, for purposes of interpretation of the bid.

## 11. Documents comprising the Bid: Financial Component

- 11.1. The second bid envelope shall contain the financial documents for the Bid as specified in **Section VIII (Checklist of Technical and Financial Documents)**.
- 11.2. If the Bidder claims preference as a Domestic Bidder or Domestic Entity, a certification issued by DTI shall be provided by the Bidder in accordance with Section 43.1.3 of the 2016 revised IRR of RA No. 9184.
- 11.3. Any bid exceeding the ABC indicated in paragraph 1 of the **IB** shall not be accepted.
- 11.4. For Foreign-funded Procurement, a ceiling may be applied to bid prices provided the conditions are met under Section 31.2 of the 2016 revised IRR of RA No. 9184.

## 12. Bid Prices

- 12.1. Prices indicated on the Price Schedule shall be entered separately in the following manner:
  - a. For Goods offered from within the Procuring Entity's country:
    - i. The price of the Goods quoted EXW (ex-works, ex-factory, ex-warehouse, ex-showroom, or off-the-shelf, as applicable);
    - ii. The cost of all customs duties and sales and other taxes already paid or payable;
    - iii. The cost of transportation, insurance, and other costs incidental to delivery of the Goods to their final destination; and
    - iv. The price of other (incidental) services, if any, listed in the **BDS**.
  - b. For Goods offered from abroad:
    - i. Unless otherwise stated in the **BDS**, the price of the Goods shall be quoted delivered duty paid (DDP) with the place of destination in the Philippines as specified in the **BDS**. In quoting the price, the Bidder shall be free to use transportation through carriers registered in any eligible country. Similarly, the Bidder may obtain insurance services from any eligible source country.
    - ii. The price of other (incidental) services, if any, as listed in the **BDS**.

## 13. Bid and Payment Currencies

- 13.1. For Goods that the Bidder will supply from outside the Philippines, the bid prices may be quoted in the local currency or tradeable currency accepted by the BSP at the discretion of the Bidder. However, for purposes of bid evaluation, Bids denominated in foreign currencies, shall be converted to Philippine currency based on the exchange rate as published in the BSP reference rate

bulletin on the day of the bid opening.

- 13.2. Payment of the contract price shall be made in:
  - a. Philippine Pesos.

## 14. Bid Security

- 14.1. The Bidder shall submit a Bid Securing Declaration<sup>2</sup> or any form of Bid Security in the amount indicated in the **BDS**, which shall be not less than the percentage of the ABC in accordance with the schedule in the **BDS**.
- 14.2. The Bid and bid security shall be valid until **August 31, 2023**. Any Bid not accompanied by an acceptable bid security shall be rejected by the Procuring Entity as non- responsive.

## 15. Sealing and Marking of Bids

Each Bidder shall submit one copy of the first and second components of its Bid.

The Procuring Entity may request additional hard copies and/or electronic copies of the Bid. However, failure of the Bidders to comply with the said request shall not be a ground for disqualification.

If the Procuring Entity allows the submission of bids through online submission or any other electronic means, the Bidder shall submit an electronic copy of its Bid, which must be digitally signed. An electronic copy that cannot be opened or is corrupted shall be considered non-responsive and, thus, automatically disqualified.

## 16. Deadline for Submission of Bids

- 16.1. The Bidders shall submit on the specified date and time and either at its physical address or through online submission as indicated in paragraph 7 of the **IB**.

## 17. Opening and Preliminary Examination of Bids

- 17.1. The BAC shall open the Bids in public at the time, on the date, and at the place specified in paragraph 9 of the **IB**. The Bidders' representatives who are present shall sign a register evidencing their attendance. In case videoconferencing, webcasting or other similar technologies will be used, attendance of participants shall likewise be recorded by the BAC Secretariat.

In case the Bids cannot be opened as scheduled due to justifiable reasons, the rescheduling requirements under Section 29 of the 2016 revised IRR of RA No. 9184 shall prevail.

- 17.2. The preliminary examination of bids shall be governed by Section 30 of the 2016 revised IRR of RA No. 9184.

---

<sup>2</sup> In the case of Framework Agreement, the undertaking shall refer to entering into contract with the Procuring Entity and furnishing of the performance security or the performance securing declaration within ten (10) calendar days from receipt of Notice to Execute Framework Agreement.

## 18. Domestic Preference

- 18.1. The Procuring Entity will grant a margin of preference for the purpose of comparison of Bids in accordance with Section 43.1.2 of the 2016 revised IRR of RA No. 9184.

## 19. Detailed Evaluation and Comparison of Bids

- 19.1. The Procuring Entity's BAC shall immediately conduct a detailed evaluation of all Bids rated "*passed*," using non-discretionary pass/fail criteria. The BAC shall consider the conditions in the evaluation of Bids under Section 32.2 of the 2016 revised IRR of RA No. 9184.
- 19.2. If the Project allows partial bids, bidders may submit a proposal on any of the lots or items, and evaluation will be undertaken on a per lot or item basis, as the case may be. In this case, the Bid Security as required by **ITB** Clause 14 shall be submitted for each lot or item separately.
- 19.3. The descriptions of the lots or items shall be indicated in **Section VII (Technical Specifications)**, although the ABCs of these lots or items are indicated in the **BDS** for purposes of the NFCC computation pursuant to Section 23.4.2.6 of the 2016 revised IRR of RA No. 9184. The NFCC must be sufficient for the total of the ABCs for all the lots or items participated in by the prospective Bidder.
- 19.4. The Project shall be awarded as follows:

**One Project having several items grouped into several lots, which shall be awarded as separate contracts per lot**

- 19.5. Except for bidders submitting a committed Line of Credit from a Universal or Commercial Bank in lieu of its NFCC computation, all Bids must include the NFCC computation pursuant to Section 23.4.1.4 of the 2016 revised IRR of RA No. 9184, which must be sufficient for the total of the ABCs for all the lots or items participated in by the prospective Bidder. For bidders submitting the committed Line of Credit, it must be at least equal to ten percent (10%) of the ABCs for all the lots or items participated in by the prospective Bidder.

## 20. Post-Qualification

- 20.2. Within a non-extendible period of five (5) calendar days from receipt by the Bidder of the notice from the BAC that it submitted the Lowest Calculated Bid, the Bidder shall submit its latest income and business tax returns filed and paid through the BIR Electronic Filing and Payment System (eFPS), the appropriate licenses and permits required by law and other documents, if any, as stated in the **BDS**.

## **21. Signing of the Contract**

- 21.1. The documents required in Section 37.2 of the 2016 revised IRR of RA No. 9184 shall form part of the Contract. Additional Contract documents are indicated in the **BDS**.

## ***Section III. Bid Data Sheet***

### **Notes on the Bid Data Sheet**

The Bid Data Sheet (BDS) consists of provisions that supplement, amend, or specify in detail, information, or requirements included in the ITB found in Section II, which are specific to each procurement.

This Section is intended to assist the Procuring Entity in providing the specific information in relation to corresponding clauses in the ITB and has to be prepared for each specific procurement.

The Procuring Entity should specify in the BDS information and requirements specific to the circumstances of the Procuring Entity, the processing of the procurement, and the bid evaluation criteria that will apply to the Bids. In preparing the BDS, the following aspects should be checked:

- a. Information that specifies and complements provisions of the ITB must be incorporated.
- b. Amendments and/or supplements, if any, to provisions of the ITB as necessitated by the circumstances of the specific procurement, must also be incorporated.

# Bid Data Sheet

| ITB Clause |  |                        |                           |     |       |                                       |  |  |  |                        |  |  |                        |
|------------|--|------------------------|---------------------------|-----|-------|---------------------------------------|--|--|--|------------------------|--|--|------------------------|
| 5.3        | <p>For this purpose, contracts similar to the Project shall be:</p> <p style="margin-left: 40px;">a. <b><u>Supply and Delivery of Cartons &amp; other food packing materials.</u></b></p> <p style="margin-left: 40px;">b. completed within Five (5) years prior to the deadline for the submission and receipt of bids.</p>   |                        |                           |     |       |                                       |  |  |  |                        |  |  |                        |
| 14.1       | <p>The bid security shall be in the form of a Bid Securing Declaration, or any of the following forms and amounts:</p> <p style="margin-left: 40px;">a. The amount of not less than <b><u>P91,175.00</u></b> [equivalent to two percent (2%) of ABC], if bid security is in cash, cashier's/manager's check, bank draft/guarantee or irrevocable letter of credit; or</p> <p style="margin-left: 40px;">b. The amount of not less than <b><u>P227,937.50</u></b> [equivalent to five percent (5%) of ABC] if bid security is in Surety Bond.</p> <p>NOTE: The above computation is for bid submissions covering all lots with the total ABC of Five Million Two Hundred Nineteen Thousand Seven Hundred Seventy-Nine Pesos and 61/100 ( <b><u>P4,558,750.01</u></b>). For purposes of determining the amount of the bid security in procurement allowing bids for a single or multiple lots, if applicable, the bid security shall be based upon the sum of the ABC for each of the lots or items for which bids are submitted.</p> <p>The bid securities must be valid until August 31, 2023.</p> |                        |                           |     |       |                                       |  |  |  |                        |  |  |                        |
| 15         | <p>Each Bidder shall submit one (1) original, one (1) duplicate and one (1) PDF file in USB copies of the first (technical) and second (financial) components of its bid. Documents to be submitted shall be properly tabbed and labeled.</p> <p>“Do not open before 11:00AM on July 25, 2023.”</p>  |                        |                           |     |       |                                       |  |  |  |                        |  |  |                        |
| 19.3       | <p>The computation of a prospective bidder's NFCC must be at least equal to the ABC to be bid, pursuant to Section 23.4.1.4 of the Revised IRR of RA No. 9184.</p> <table border="1" style="width: 100%; border-collapse: collapse; margin-top: 10px;"> <thead> <tr> <th style="text-align: center;">Lots</th> <th style="text-align: center;">Particulars / Description</th> <th style="text-align: center;">ABC</th> </tr> </thead> <tbody> <tr> <td style="text-align: center;">Lot 1</td> <td>CORR. CARTON FOR MINOLA PE CONTAINERS</td> <td></td> </tr> <tr> <td></td> <td>1.. CORR. CARTON FOR MINOLA PE 4 X 3.5LITERS</td> <td style="text-align: center;">Item 1 - P1,093,746.16</td> </tr> <tr> <td></td> <td>2. CORR. CARTON FOR MINOLA PE 10 X 1.75 LITERS</td> <td style="text-align: center;">Item 2 - P1,293,867.30</td> </tr> </tbody> </table>   | Lots                   | Particulars / Description | ABC | Lot 1 | CORR. CARTON FOR MINOLA PE CONTAINERS |  |  | 1.. CORR. CARTON FOR MINOLA PE 4 X 3.5LITERS | Item 1 - P1,093,746.16 |  | 2. CORR. CARTON FOR MINOLA PE 10 X 1.75 LITERS | Item 2 - P1,293,867.30 |
| Lots       | Particulars / Description  | ABC                    |                           |     |       |                                       |  |  |  |                        |  |  |                        |
| Lot 1      | CORR. CARTON FOR MINOLA PE CONTAINERS  |                        |                           |     |       |                                       |  |  |  |                        |  |  |                        |
|            | 1.. CORR. CARTON FOR MINOLA PE 4 X 3.5LITERS   | Item 1 - P1,093,746.16 |                           |     |       |                                       |  |  |  |                        |  |  |                        |
|            | 2. CORR. CARTON FOR MINOLA PE 10 X 1.75 LITERS   | Item 2 - P1,293,867.30 |                           |     |       |                                       |  |  |  |                        |  |  |                        |

|      |  |  |                        |
|------|--|--|------------------------|
|      |  |  | Total - P2,387,613.46  |
|      | Lot 2  | CORRUGATED CARTON FOR SHORTENING PRODUCTS      |                        |
|      |  | 1. CORR. CARTON BOXES FOR VEGETABLE SHORTENING | Item 1 - P1,978,698.15 |
|      |  | 2. CORR. CARTON FOR BM 20K AND BOS20K          | Item 2 - P192,438.40   |
|      |  |  | Total - P2,171,136.55  |
|      |  | Total ABC                                      | <b>P 4,558,750.01</b>  |
| 20.2 | <p>The bidder shall be required to submit the following eligibility documents during post-qualification:</p> <ul style="list-style-type: none"> <li>a) Latest Income and Business Tax Returns filed and paid through the BIR Electronic Filing and Payment System (eFPS);</li> <li>b) Registration certificate from Securities and Exchange Commission (SEC), Department of Trade and Industry (DTI) for sole proprietorship, or Cooperative Development Authority (CDA) for cooperatives or its equivalent document;</li> <li>c) Mayor's or Business permit issued by the city or municipality where the principal place of business of the prospective bidder is located, or the equivalent document for Exclusive Economic Zones or Areas;</li> <li>d) Tax clearance per E.O. No. 398, s. 2005, as finally reviewed and approved by the Bureau of Internal Revenue (BIR);</li> <li>e) The Supplier's audited financial statements, showing, among others, the Supplier's total and current assets and liabilities, stamped "received" by the BIR or its duly accredited and authorized institutions, for the preceding calendar year which should not be earlier than two (2) years from the date of bid submission;</li> <li>f) Photocopy of Single Largest Completed Contract or Purchase Order;</li> <li>g) Others, if any:</li> </ul> <p>Refer to Other Documents in the Checklist of Eligibility (Legal, Technical and Financial Documents), Financial and Other Documents to be submitted pursuant to Section 34.2 of the 2016 Revised IRR, as contained in Other Documents required from the bidder with the Single or Lowest Calculated Bidder.</p> |  |                        |



|      |   |
|------|---|
| 21.1 | <p>Documents required in Section 37.2 of the 2016 revised IRR of RA No. 9184 are as follows:</p> <ul style="list-style-type: none"><li>a) Contract Agreement;</li><li>b) Bidding Documents;</li><li>c) Winning bidder's bid, including the Eligibility requirements, Technical and Financial Proposals, and all other documents/statements submitted;</li><li>d) Performance Security;</li><li>e) Notice of Award of Contract; and</li><li>f) Other contract documents that may be required by existing laws and/or the Procuring Entity concerned:</li></ul> <p>Refer to Section VIII. Checklist of Technical and Financial Documents for other documents to be submitted pursuant to Section 37.2 of the 2016 Revised IRR, as contained in Other Contract Documents required from the bidder with the LCRB, HRRB, SCRB or SRRB.</p> <p>The contract shall be subject to the review and approval of the Office of the Government Corporate Counsel. Any of its ensuing comments, recommendations, or directives shall form part of the contract.</p> |
|------|---|

## ***Section IV. General Conditions of Contract***

### **Notes on the General Conditions of Contract**

The General Conditions of Contract (GCC) in this Section, read in conjunction with the Special Conditions of Contract in Section V and other documents listed therein, should be a complete document expressing all the rights and obligations of the parties.

Matters governing performance of the Supplier, payments under the contract, or matters affecting the risks, rights, and obligations of the parties under the contract are included in the GCC and Special Conditions of Contract.

Any complementary information, which may be needed, shall be introduced only through the Special Conditions of Contract.

## 1. **Scope of Contract**

This Contract shall include all such items, although not specifically mentioned, that can be reasonably inferred as being required for its completion as if such items were expressly mentioned herein. All the provisions of RA No. 9184 and its 2016 revised IRR, including the Generic Procurement Manual, and associated issuances, constitute the primary source for the terms and conditions of the Contract, and thus, applicable in contract implementation. Herein clauses shall serve as the secondary source for the terms and conditions of the Contract.

This is without prejudice to Sections 74.1 and 74.2 of the 2016 revised IRR of RA No. 9184 allowing the GPPB to amend the IRR, which shall be applied to all procurement activities, the advertisement, posting, or invitation of which were issued after the effectivity of the said amendment.

Additional requirements for the completion of this Contract shall be provided in the **Special Conditions of Contract (SCC)**.

## 2. **Advance Payment and Terms of Payment**

2.1. Advance payment of the contract amount is provided under Annex “D” of the revised 2016 IRR of RA No. 9184.

2.2. The Procuring Entity is allowed to determine the terms of payment on the partial or staggered delivery of the Goods procured, provided such partial payment shall correspond to the value of the goods delivered and accepted in accordance with prevailing accounting and auditing rules and regulations. The terms of payment are indicated in the **SCC**.

## 3. **Performance Security**

Within ten (10) calendar days from receipt of the Notice of Award by the Bidder from the Procuring Entity but in no case later than the signing of the Contract by both parties, the successful Bidder shall furnish the performance security in any of the forms prescribed in Section 39 of the 2016 revised IRR of RA No. 9184.

## 4. **Inspection and Tests**

The Procuring Entity or its representative shall have the right to inspect and/or to test the Goods to confirm their conformity to the Project specifications at no extra cost to the Procuring Entity in accordance with the Generic Procurement Manual. In addition to tests in the **SCC, Section VII (Technical Specifications)** shall specify what inspections and/or tests the Procuring Entity requires, and where they are to be conducted. The Procuring Entity shall notify the Supplier in writing, in a timely manner, of the identity of any representatives retained for these purposes.

All reasonable facilities and assistance for the inspection and testing of Goods, including access to drawings and production data, shall be provided by the Supplier to the authorized inspectors at no charge to the Procuring Entity.

## **5. Warranty**

- 5.1 In order to assure that manufacturing defects shall be corrected by the Supplier, a warranty shall be required from the Supplier as provided under Section 62.1 of the 2016 revised IRR of RA No. 9184.
- 5.2 The Procuring Entity shall promptly notify the Supplier in writing of any claims arising under this warranty. Upon receipt of such notice, the Supplier shall, repair or replace the defective Goods or parts thereof without cost to the Procuring Entity, pursuant to the Generic Procurement Manual.

## **6. Liability of the Supplier**

The Supplier's liability under this Contract shall be as provided by the laws of the Republic of the Philippines.

If the Supplier is a joint venture, all partners to the joint venture shall be jointly and severally liable to the Procuring Entity.

## *Section V. Special Conditions of Contract*

### **Notes on the Special Conditions of Contract**

Similar to the BDS, the clauses in this Section are intended to assist the Procuring Entity in providing contract-specific information in relation to corresponding clauses in the GCC found in Section IV.

The Special Conditions of Contract (SCC) complement the GCC, specifying contractual requirements linked to the special circumstances of the Procuring Entity, the Procuring Entity's country, the sector, and the Goods purchased. In preparing this Section, the following aspects should be checked:

- a. Information that complements provisions of the GCC must be incorporated.
- b. Amendments and/or supplements to provisions of the GCC as necessitated by the circumstances of the specific purchase, must also be incorporated.

However, no special condition which defeats or negates the general intent and purpose of the provisions of the GCC should be incorporated herein.

## Special Conditions of Contract

| GCC Clause |   |
|------------|---|
| 1          | <p>Additional requirements for the completion of this Contract shall be:</p> <p>For purposes of this clause, the Procuring Entities representative are:</p> <p>Jazzzer Gel B. Panganiban +639431281302</p> <p><b>Delivery and Documents – (IF APPLICABLE)</b></p> <p>For purposes of the Contract, “EXW,” “FOB,” “FCA,” “CIF,” “CIP,” “DDP” and other trade terms used to describe the obligations of the parties shall have the meanings assigned to them by the current edition of INCOTERMS published by the International Chamber of Commerce, Paris. The Delivery terms of this Contract shall be as follows:</p> <p><i>[For Goods supplied from abroad:]</i> “The delivery terms applicable to the Contract are DDP delivered to Coconut Industry Investment Fund - San Pablo Manufacturing Corporation (SPMC) with business address at San Pablo Manufacturing Corporation, CAIP SEZ, Brgy San Antonio, San Pascual, Batangas City. In accordance with INCOTERMS.”</p> <p><i>[For Goods supplied from within the Philippines:]</i> “The delivery terms applicable to this Contract are delivered to Coconut Industry Investment Fund - San Pablo Manufacturing Corporation (SPMC) with business address at San Pablo Manufacturing Corporation, CAIP SEZ, Brgy San Antonio, San Pascual, Batangas City. Risk and title will pass from the Supplier to the Procuring Entity upon receipt and final acceptance of the Goods at their final destination.”</p> <p>Incidental Services -</p> <ul style="list-style-type: none"> <li>a) performance or supervision of on-site assembly and/or start-up of the supplied Goods;</li> <li>b) furnishing of tools required for assembly and/or maintenance of the supplied Goods;</li> <li>c) furnishing of a detailed operations and maintenance manual for each appropriate unit of the supplied Goods;</li> <li>d) performance or supervision or maintenance and/or repair of the supplied Goods, for a period of time agreed by the parties, provided that this service shall not relieve the Supplier of any warranty obligations under this Contract; and</li> <li>e) training of the Procuring Entity’s personnel, at the Supplier’s plant and/or on-site, in assembly, start-up, operation, maintenance, and/or repair of the supplied Goods.</li> </ul> |

f) The Contract price for the Goods shall include the prices charged by the Supplier for incidental services and shall not exceed the prevailing rates charged to other parties by the Supplier for similar services.

Packaging –

The Supplier shall provide such packaging of the Goods as is required to prevent their damage or deterioration during transit to their final destination, as indicated in this Contract. The packaging shall be sufficient to withstand, without limitation, rough handling during transit and exposure to extreme temperatures, salt and precipitation during transit, and open storage. Packaging case size and weights shall take into consideration, where appropriate, the remoteness of the Goods' final destination and the absence of heavy handling facilities at all points in transit.

The packaging, marking, and documentation within and outside the packages shall comply strictly with such special requirements as shall be expressly provided for in the Contract, including additional requirements, if any, specified below, and in any subsequent instructions ordered by the Procuring Entity.

The outer packaging must be clearly marked on at least four (4) sides as follows:

Name of the Procuring Entity

Name of the Supplier

Contract Description

Final Destination

Gross weight

Any special lifting instructions

Any special handling instructions

Any relevant HAZCHEM classifications

A packaging list identifying the contents and quantities of the package is to be placed on an accessible point of the outer packaging if practical. If not practical the packaging list is to be placed inside the outer packaging but outside the secondary packaging.

Transportation –

Where the Supplier is required under Contract to deliver the Goods CIF, CIP, or DDP, transport of the Goods to the port of destination or such other named place of destination in the Philippines, as shall be specified in this Contract,

|     |   |
|-----|---|
|     | <p>shall be arranged and paid for by the Supplier, and the cost thereof shall be included in the Contract Price.</p> <p>Where the Supplier is required under this Contract to transport the Goods to a specified place of destination within the Philippines, defined as the Project Site, transport to such place of destination in the Philippines, including insurance and storage, as shall be specified in this Contract, shall be arranged by the Supplier, and related costs shall be included in the contract price.</p> <p>Where the Supplier is required under Contract to deliver the Goods CIF, CIP or DDP, Goods are to be transported on carriers of Philippine registry. In the event that no carrier of Philippine registry is available, Goods may be shipped by a carrier which is not of Philippine registry provided that the Supplier obtains and presents to the Procuring Entity certification to this effect from the nearest Philippine consulate to the port of dispatch. In the event that carriers of Philippine registry are available but their schedule delays the Supplier in its performance of this Contract the period from when the Goods were first ready for shipment and the actual date of shipment the period of delay will be considered force majeure.</p> <p>The Procuring Entity accepts no liability for the damage of Goods during transit other than those prescribed by INCOTERMS for DDP deliveries. In the case of Goods supplied from within the Philippines or supplied by domestic Suppliers risk and title will not be deemed to have passed to the Procuring Entity until their receipt and final acceptance at the final destination.</p> <p>Intellectual Property Rights –</p> <p>The Supplier shall indemnify the Procuring Entity against all third-party claims of infringement of patent, trademark, or industrial design rights arising from use of the Goods or any part thereof.</p> |
| 2.2 | <p>Partial payment is allowed upon submission of an irrevocable letter of credit or bank guarantee issued by a Universal or Commercial Bank in favor of the Procuring Entity. The advance payment not exceeding fifteen percent (15%) of the contract amount shall be allowed and paid within sixty (60) calendar days from signing of the contract. The irrevocable letter of credit or bank guarantee must be for an equivalent amount and shall remain valid until the goods are delivered and installed to be accompanied by a claim for advance payment (as stated in Annex “D” of IRR 2016 of RA9184)</p> <p>Seven days after submission of the following:</p> <ol style="list-style-type: none"> <li>1. Sales Invoice;</li> <li>2. Delivery Receipt; and</li> <li>3. Certificate of Acceptance and Receiving Report</li> </ol>   |
| 4   | <p>The inspections and tests that will be conducted are:</p>  |



|   |   |
|---|---|
|   | <p>For all Lots:</p> <p>Delivery of the product shall be accompanied by the following documents:</p> <ol style="list-style-type: none"> <li>1. Valid Certificate of Analysis/Inspection certified by the bidder's licensed chemist or any other competent personnel showing the Manufacturing date and compliance with the parameters required under Section VII – Technical Specifications.</li> <li>2. Safety Data Sheet, Product Technical Sheet</li> <li>3. The delivered products must pass the following tests: <ol style="list-style-type: none"> <li>a. Edge Crust Test 2 Single</li> <li>b. Box Compression Test</li> <li>c. Water Resistance of the Gluing</li> <li>d. Cobb Sizing Tester</li> <li>e. Paper Grammage and Thickness</li> <li>f. Scuff Resistance Test</li> <li>g. Chemical Analysis in Corrugated Box Testing</li> </ol> </li> </ol> |
| 5 | <p>Warranty</p> <p>For the procurement of goods, a warranty shall be required from the contract awardee for a minimum period of three (3) months, in the case of Expendable Supplies, and one (1) year, in the case of Non-Expendable Supplies, after the acceptance by the Procuring Entity of the delivered supplies.</p> <p>The obligation for the warranty shall be covered by either:</p> <ol style="list-style-type: none"> <li>a) Retention money in an amount equivalent to at least one percent (1%) of every progress payment; or</li> <li>b) Special bank guarantee equivalent to at least one percent (1%) of the total contract price. The special bank guarantee must be contract specific, that is, it shall be executed for the special purpose of covering the warranty for the subject procurement contract.</li> </ol>                     |

## *Section VI. Schedule of Requirements*

The delivery schedule expressed as weeks/months stipulates hereafter a delivery date which is the date of delivery to the project site.

| Lots  | Particulars / Description   | Quantity  | TOTAL                                 | Delivered, Weeks/Months   |
|-------|---|---|---------------------------------------|---|
| Lot 1 | <p>CORR. CARTON FOR MINOLA PE CONTAINERS</p> <p>1. CORR. CARTON FOR MINOLA PE 4 X 3.5LITERS</p> <p>2. CORR. CARTON FOR MINOLA PE 10 X 1.75 LITERS</p> | <p>5,000 sets (minimum) to 10,000 sets (maximum)</p> <p>5,000 sets (minimum) to 10,000 sets (maximum)</p> | <p>39,686 sets</p> <p>34,094 sets</p> | <p>1. Initial Date of Delivery is ten (10) days upon receipt of Notice to Proceed;</p> <p>2. Succeeding deliveries must be ten (10) days upon receipt of Notice to Deliver.</p> |
| Lot 2 | <p>CORRUGATED CARTON FOR SHORTENING PRODUCTS</p> <p>1. CORR. CARTON BOXES FOR VEGETABLE SHORTENING</p> <p>2. CORR. CARTON FOR BM 20K AND BOS 20K</p>  | <p>5,000 pcs (minimum) to 10,000 pcs (maximum)</p> <p>5,000 pcs (minimum)</p>                             | <p>61,815 pcs</p> <p>5,680 pcs</p>    | <p>1. Initial Date of Delivery is ten (10) days upon receipt of Notice to Proceed;</p> <p>2. Succeeding deliveries must be ten (10) days upon receipt of Notice to Deliver.</p> |

**I hereby undertake to comply and deliver all the above requirements.**

\_\_\_\_\_  
**Signature Over Printed Name of Representative**

Date \_\_\_\_\_

\_\_\_\_\_  
**Name of the Company/ Bidder:**

## ***Section VII. Technical Specifications***

### **Notes for Preparing the Technical Specifications**

A set of precise and clear specifications is a prerequisite for Bidders to respond realistically and competitively to the requirements of the Procuring Entity without qualifying their Bids. In the context of Competitive Bidding, the specifications (*e.g.* production/delivery schedule, manpower requirements, and after-sales service/parts, descriptions of the lots or items) must be prepared to permit the widest possible competition and, at the same time, present a clear statement of the required standards of workmanship, materials, and performance of the goods and services to be procured. Only if this is done will the objectives of transparency, equity, efficiency, fairness, and economy in procurement be realized, responsiveness of bids be ensured, and the subsequent task of bid evaluation and post-qualification facilitated. The specifications should require that all items, materials and accessories to be included or incorporated in the goods be new, unused, and of the most recent or current models, and that they include or incorporate all recent improvements in design and materials unless otherwise provided in the Contract.

Samples of specifications from previous similar procurements are useful in this respect. The use of metric units is encouraged. Depending on the complexity of the goods and the repetitiveness of the type of procurement, it may be advantageous to standardize the General Technical Specifications and incorporate them in a separate subsection. The General Technical Specifications should cover all classes of workmanship, materials, and equipment commonly involved in manufacturing similar goods. Deletions or addenda should then adapt the General Technical Specifications to the particular procurement.

Care must be taken in drafting specifications to ensure that they are not restrictive. In the specification of standards for equipment, materials, and workmanship, recognized Philippine and international standards should be used as much as possible. Where other particular standards are used, whether national standards or other standards, the specifications should state that equipment, materials, and workmanship that meet other authoritative standards, and which ensure at least a substantially equal quality than the standards mentioned, will also be acceptable. The following clause may be inserted in the Special Conditions of Contract or the Technical Specifications.

#### **Sample Clause: Equivalency of Standards and Codes**

Wherever reference is made in the Technical Specifications to specific standards and codes to be met by the goods and materials to be furnished or tested, the provisions of the latest edition or revision of the relevant standards and codes shall apply, unless otherwise expressly stated in the Contract. Where such standards and codes are national or relate to a particular country or region, other authoritative standards that ensure substantial equivalence to the standards and codes specified will be acceptable.

Reference to brand name and catalogue number should be avoided as far as possible; where unavoidable they should always be followed by the words “*or at least equivalent.*” References to brand names cannot be used when the funding source is the GOP.

Where appropriate, drawings, including site plans as required, may be furnished by the Procuring Entity with the Bidding Documents. Similarly, the Supplier may be requested to provide drawings or samples either with its Bid or for prior review by the Procuring Entity during contract execution.

Bidders are also required, as part of the technical specifications, to complete their statement of compliance demonstrating how the items comply with the specification.

# Technical Specifications

*[Bidders must state here either “Comply” or “Not Comply” against each of the individual parameters of each Specification stating the corresponding performance parameter of the equipment offered. Statements of “Comply” or “Not Comply” must be supported by evidence in a Bidders Bid and cross-referenced to that evidence. Evidence shall be in the form of manufacturer’s un-amended sales literature, unconditional statements of specification and compliance issued by the manufacturer, samples, independent test data etc., as appropriate. A statement that is not supported by evidence or is subsequently found to be contradicted by the evidence presented will render the Bid under evaluation liable for rejection. A statement either in the Bidder's statement of compliance or the supporting evidence that is found to be false either during Bid evaluation, post-qualification or the execution of the Contract may be regarded as fraudulent and render the Bidder or supplier liable for prosecution subject to the applicable laws and issuances.]*

| <b>Lots</b> | <b>Specification</b>   | <b>Statement of Compliance</b><br><i>State either “Comply” or “Not Comply”</i> |
|-------------|--|--|
| Lot 1       | <p>Item 1 - CORR. CARTON FOR MINOLA PE 4 X 3.5 LITERS</p> <p>L x W x H (OD): 408 x 278 x 314mm</p> <p>L x W x H (ID): 405 x 275 x 308mm</p> <p>Type: RSC (Regular Slotted Carton)</p> <p>Flute: B</p> <p>ECT 29</p> <p>Paper Combination: 175/150/175 gsm</p> <p>Partition (long): 403 x 308mm, 1pc</p> <p>Partition (short): 272 x 308mm, 1pc with slit</p> <p>Three (3) Color Print</p> <p>To contain 12.8kg product. (tare weight: from 0.498 – 0.621)</p> <p>Stacking Height: 5</p> <p>Item 2 - CORR. CARTON FOR MINOLA PE 10 X 1.75 LITERS</p> <p>L x W x H (OD): 538 x 330 x 251mm</p> |  |

|       |  |  |
|-------|--|--|
|       | <p>L x W x H (ID): 535 x 327 x 245mm</p> <p>Type: RSC (Regular Slotted Carton)</p> <p>Flute: B</p> <p>ECT 29</p> <p>Paper Combination: 175/150/175 gsm</p> <p>Partition (long): 516 x 243mm, 1pc with slit</p> <p>Partition (short): 321 x 243mm, 4pcs with slit</p> <p>Three (3) Color Print</p> <p>To contain 16kg product. (tare Weight: from 0.723 – 0.874)</p> <p>Stacking Height: 6</p>  |  |
| Lot 2 | <p>Item 1 - CORR. CARTON BOXES FOR VEGETABLESHORTENING 20K</p> <p>L x W x H (OD): 464 x 268 x 230mm</p> <p>L x W x H (ID): 456 x 260 x 216mm</p> <p>Type: RSC (Regular Slotted Carton)</p> <p>Flute: BC</p> <p>ECT 51</p> <p>Paper Combination: TL175/CM150/TL175/CM150/TL175 gsm</p> <p>Three (3) Color Print</p> <p>To contain 20kg product (Tare weight: from 0.550 – 0.621)</p> <p>Stacking Height: 5</p> <p>Item 2 - CORRUGATED CARTON FOR BM 20K AND BOS 20K</p> <p>Plain Carton</p> <p>L x W x H (OD): 369 x 339 x 254mm</p> <p>Type: RSC (Regular Slotted Carton)</p> <p>Flute: BC</p> <p>ECT 51</p> |  |

|  |  |  |
|--|--|--|
|  | Paper Combination: TL175/CM150/TL175/CM150/TL175 gsm<br>To contain 20kg product. (tare Weight: from 0.637 – 0.645)<br>Stacking Height: 4 |  |
|--|--|--|

**I hereby certify to comply with all the above Technical Specifications.**

\_\_\_\_\_  
**Signature Over Printed Name of Representative**  
**Date** \_\_\_\_\_

\_\_\_\_\_  
**Name of the Company/ Bidder:**

## ***Section VIII. Checklist of Technical and Financial Documents***

### **Notes on the Checklist of Technical and Financial Documents**

The prescribed documents in the checklist are mandatory to be submitted in the Bid, but shall be subject to the following:

- a. GPPB Resolution No. 09-2020 on the efficient procurement measures during a State of Calamity or other similar issuances that shall allow the use of alternate documents in lieu of the mandated requirements; or
- b. Any subsequent GPPB issuances adjusting the documentary requirements after the effectivity of the adoption of the PBDs.

The BAC shall be checking the submitted documents of each Bidder against this checklist to ascertain if they are all present, using a non-discretionary “pass/fail” criterion pursuant to Section 30 of the 2016 revised IRR of RA No. 9184.

If a bidder submits the required document, it shall be rated “passed” for that particular requirement. In this regard, bids that fail to include any requirement or are incomplete or patently insufficient shall be considered as “failed”. Otherwise, the BAC shall rate the bidder “passed” in relation to the eligibility and technical documents in the first envelope.



# Checklist of Technical and Financial Documents

INSTRUCTIONS: The following required documents shall be accomplished, satisfied and submitted in chronological order to the BAC Secretariat, 16<sup>th</sup> Floor Securities and Exchange Commission (SEC) formerly UCPB Building, Makati Avenue, Makati City, on July 25, 2023, not later than 10:00AM. Prospective Bidders are required to submit in three (3) copies (1 original, 1 duplicate copy and 1 PDF File in USB) each of the required documents. All pages of the Bid, including attachments thereto shall be initialed by the person signing the Bid.

## I. TECHNICAL COMPONENT ENVELOPE

### *Class "A" Documents*

#### Legal Documents

- (a) Valid PhilGEPS Registration Certificate (Platinum Membership) (all pages) **in accordance with Section 8.5.2 of the IRR;**

#### Technical Documents

- (b) Statement of the prospective bidder of all its ongoing government and private contracts, including contracts awarded but not yet started, if any, whether similar or not similar in nature and complexity to the contract to be bid; and
- (c) Statement of the bidder's Single Largest Completed Contract (SLCC) similar to the contract to be bid, except under conditions provided for in Sections 23.4.1.3 and 23.4.2.4 of the 2016 revised IRR of RA No. 9184, within the relevant period as provided in the Bidding Documents; **and**
- (d) Original copy of Bid Security. If in the form of a Surety Bond, submit also a certification issued by the Insurance Commission or Original copy of Notarized Bid Securing Declaration; and
- (e) Conformity with the Technical Specifications, which may include production/delivery schedule, manpower requirements, and/or after-sales/parts, if applicable; **and**
- (f) Original duly signed Omnibus Sworn Statement (OSS) **and** if applicable, Original Notarized Secretary's Certificate in case of a corporation, partnership, or cooperative; or Original Special Power of Attorney of all members of the joint venture giving full power and authority to its officer to sign the OSS and do acts to represent the Bidder.
- (g) Others:

1. Affidavit of Compliance with Technical Specifications;

2. Safety Data Sheet, Product Technical Sheet; and

3. Method of production/process Flow (Methodology)

#### Financial Documents

- (h) The prospective bidder's computation of Net Financial Contracting Capacity (NFCC) or a committed Line of Credit from a Universal or Commercial Bank in lieu of its NFCC computation.

*Class “B” Documents*

- (i) If applicable, a duly signed joint venture agreement (JVA) in case the joint venture is already in existence **or** duly notarized statements from all the potential joint venture partners stating that they will enter into and abide by the provisions of the JVA in the instance that the bid is successful.

**II. FINANCIAL COMPONENT ENVELOPE**

- (j) Original of duly signed and accomplished Financial Bid Form; **and**
- (k) Original of duly signed and accomplished Price Schedule(s).

*Other documentary requirements under RA No. 9184 (as applicable)*

- (l) *[For foreign bidders claiming by reason of their country’s extension of reciprocal rights to Filipinos]* Certification from the relevant government office of their country stating that Filipinos are allowed to participate in government procurement activities for the same item or product.
- (m) Certification from the DTI if the Bidder claims preference as a Domestic Bidder or Domestic Entity.

## *Section IX. Bidding Forms*

**Bid Securing Declaration Form**

*[shall be submitted with the Bid if bidder opts to provide this form of bid security]*

---

REPUBLIC OF THE PHILIPPINES)  
CITY OF \_\_\_\_\_) S.S.

**BID SECURING DECLARATION**  
**Project Identification No.: *[Insert number]***

To: *[Insert name and address of the Procuring Entity]*

I/We, the undersigned, declare that:

1. I/We understand that, according to your conditions, bids must be supported by a Bid Security, which may be in the form of a Bid Securing Declaration.
2. I/We accept that: (a) I/we will be automatically disqualified from bidding for any procurement contract with any procuring entity for a period of two (2) years upon receipt of your Blacklisting Order; and, (b) I/we will pay the applicable fine provided under Section 6 of the Guidelines on the Use of Bid Securing Declaration, within fifteen (15) days from receipt of the written demand by the procuring entity for the commission of acts resulting to the enforcement of the bid securing declaration under Sections 23.1(b), 34.2, 40.1 and 69.1, except 69.1(f), of the IRR of RA No. 9184; without prejudice to other legal action the government may undertake.
3. I/We understand that this Bid Securing Declaration shall cease to be valid on the following circumstances:
  - a. Upon expiration of the bid validity period, or any extension thereof pursuant to your request;
  - b. I am/we are declared ineligible or post-disqualified upon receipt of your notice to such effect, and (i) I/we failed to timely file a request for reconsideration or (ii) I/we filed a waiver to avail of said right; and
  - c. I am/we are declared the bidder with the Lowest Calculated Responsive Bid, and I/we have furnished the performance security and signed the Contract.

IN WITNESS WHEREOF, I/We have hereunto set my/our hand/s this \_\_\_\_\_ day of *[month]* *[year]* at *[place of execution]*.

*[Insert NAME OF BIDDER OR ITS AUTHORIZED REPRESENTATIVE]*

*[Insert signatory's legal capacity]*

Affiant

**[Jurat]**

*[Format shall be based on the latest Rules on Notarial Practice]*

**Omnibus Sworn Statement (Revised)**

*[shall be submitted with the Bid]*

---

REPUBLIC OF THE PHILIPPINES )  
CITY/MUNICIPALITY OF \_\_\_\_\_) S.S.

**AFFIDAVIT**

I, [Name of Affiant], of legal age, [Civil Status], [Nationality], and residing at [Address of Affiant], after having been duly sworn in accordance with law, do hereby depose and state that:

1. *[Select one, delete the other:]*

*[If a sole proprietorship:]* I am the sole proprietor or authorized representative of [Name of Bidder] with office address at [address of Bidder];

*[If a partnership, corporation, cooperative, or joint venture:]* I am the duly authorized and designated representative of [Name of Bidder] with office address at [address of Bidder];

2. *[Select one, delete the other:]*

*[If a sole proprietorship:]* As the owner and sole proprietor, or authorized representative of [Name of Bidder], I have full power and authority to do, execute and perform any and all acts necessary to participate, submit the bid, and to sign and execute the ensuing contract for [Name of the Project] of the [Name of the Procuring Entity], as shown in the attached duly notarized Special Power of Attorney;

*[If a partnership, corporation, cooperative, or joint venture:]* I am granted full power and authority to do, execute and perform any and all acts necessary to participate, submit the bid, and to sign and execute the ensuing contract for [Name of the Project] of the [Name of the Procuring Entity], as shown in the attached [state title of attached document showing proof of authorization (e.g., duly notarized Secretary’s Certificate, Board/Partnership Resolution, or Special Power of Attorney, whichever is applicable)];

3. [Name of Bidder] is not “blacklisted” or barred from bidding by the Government of the Philippines or any of its agencies, offices, corporations, or Local Government Units, foreign government/foreign or international financing institution whose blacklisting rules have been recognized by the Government Procurement Policy Board, **by itself or by relation, membership, association, affiliation, or controlling interest with another blacklisted person or entity as defined and provided for in the Uniform Guidelines on Blacklisting;**

4. Each of the documents submitted in satisfaction of the bidding requirements is an authentic copy of the original, complete, and all statements and information provided therein are true and correct;

5. [Name of Bidder] is authorizing the Head of the Procuring Entity or its duly authorized representative(s) to verify all the documents submitted;

6. *[Select one, delete the rest:]*

*[If a sole proprietorship:]* The owner or sole proprietor is not related to the Head of the Procuring Entity, members of the Bids and Awards Committee (BAC), the Technical

Working Group, and the BAC Secretariat, the head of the Project Management Office or the end-user unit, and the project consultants by consanguinity or affinity up to the third civil degree;

*[If a partnership or cooperative:]* None of the officers and members of *[Name of Bidder]* is related to the Head of the Procuring Entity, members of the Bids and Awards Committee (BAC), the Technical Working Group, and the BAC Secretariat, the head of the Project Management Office or the end-user unit, and the project consultants by consanguinity or affinity up to the third civil degree;

*[If a corporation or joint venture:]* None of the officers, directors, and controlling stockholders of *[Name of Bidder]* is related to the Head of the Procuring Entity, members of the Bids and Awards Committee (BAC), the Technical Working Group, and the BAC Secretariat, the head of the Project Management Office or the end-user unit, and the project consultants by consanguinity or affinity up to the third civil degree;

7. *[Name of Bidder]* complies with existing labor laws and standards; and
8. *[Name of Bidder]* is aware of and has undertaken the responsibilities as a Bidder in compliance with the Philippine Bidding Documents, which includes:
  - a. Carefully examining all of the Bidding Documents;
  - b. Acknowledging all conditions, local or otherwise, affecting the implementation of the Contract;
  - c. Making an estimate of the facilities available and needed for the contract to be bid, if any; and
  - d. Inquiring or securing Supplemental/Bid Bulletin(s) issued for the *[Name of the Project]*.
9. *[Name of Bidder]* did not give or pay directly or indirectly, any commission, amount, fee, or any form of consideration, pecuniary or otherwise, to any person or official, personnel or representative of the government in relation to any procurement project or activity.
10. **In case advance payment was made or given, failure to perform or deliver any of the obligations and undertakings in the contract shall be sufficient grounds to constitute criminal liability for Swindling (Estafa) or the commission of fraud with unfaithfulness or abuse of confidence through misappropriating or converting any payment received by a person or entity under an obligation involving the duty to deliver certain goods or services, to the prejudice of the public and the government of the Philippines pursuant to Article 315 of Act No. 3815 s. 1930, as amended, or the Revised Penal Code.**

IN WITNESS WHEREOF, I have hereunto set my hand this \_\_\_ day of \_\_\_, 20\_\_ at \_\_\_\_\_, Philippines.

*[Insert NAME OF BIDDER OR ITS AUTHORIZED REPRESENTATIVE]*

*[Insert signatory's legal capacity]*  
Affiant

**[Jurat]**

*[Format shall be based on the latest Rules on Notarial Practice]*

The undersigned is authorized to submit the bid on behalf of *[name of the bi*  
evidenced by the attached *[state the written authority]*.

We acknowledge that failure to sign each and every page of th  
attached Schedule of Prices, shall be a ground for the rejectio

Name: \_\_\_\_\_

Legal capacity: \_\_\_\_\_

Signature: \_\_\_\_\_

Duly authori

Dat

**Bid Form for the Procurement of Goods**  
(shall be submitted with the Bid)

## FINANCIAL BID FORM

Date: \_\_\_\_\_

Invitation to Bid No: \_\_\_\_\_

To: (name and address of Procuring Entity)

Having examined the Philippine Bidding Documents (PBDs) for the “**Procurement of Corrugated Cartons**” including the Supplemental or Bid Bulletin Numbers [insert numbers], the receipt of which is hereby duly acknowledged, we, the undersigned, offer to supply/deliver to (name of Procuring Entity), our services in conformity with the said Bidding Documents.

| <b>Project Name: Corrugated Cartons for San Pablo Manufacturing Corporation</b> | <b>Bid (in words)</b> | <b>Bid (in Php)</b> |
|---|-----------------------|---------------------|
| Lot 1 – Corrugated Carton for Minola PE Containers                              |                       |                     |
| Item 1 – Corr. Carton for Minola PE 4x3.5Liter                                  |                       |                     |
| Item 2 – Corr. Carton for Minola PE 10x1.75Liter                                |                       |                     |
| Lot 2 – Corrugated Carton for Shortening Products                               |                       |                     |
| Item 1 – Corr. Carton Boxes for Vegetable Shortening                            |                       |                     |
| Item 2 – Corr. Carton for BM 20k and BOS 20k                                    |                       |                     |
| <b>Total Bid</b>  |                       |                     |

Note: The total calculated bid price, as evaluated and corrected for computational errors, and other bid modifications in accordance with the Price Schedules attached herewith and made part of this Bid. The total bid price includes the cost of all taxes, such as, but not limited to: [government applicable taxes e.g. (i) Value Added Tax (VAT), (ii) Income Tax, (iii) Local Taxes, and (iv) other fiscal levies and duties], which are itemized herein or in the Price Schedules.

If our Bid is accepted, we undertake:

- To deliver the goods in accordance with the delivery schedule specified in the Schedule of Requirements of the Philippine Bidding Documents (PBDs);
- To provide a performance security in the form, amounts, and within the time prescribed in the PBDs;
- To abide by this Bid for the Bid Validity Period specified in PBDs and it shall remain binding upon us at any time before the expiration of that period

Until a formal Contract is prepared and executed, this Bid, together with your written acceptance thereof and your Notice of Award, shall be binding upon us.

We understand that you are not bound to accept the Lowest Calculated Bid or any Bid you may receive.

We certify/confirm that we comply with the eligibility requirements pursuant to the PBDs.

The undersigned is authorized to submit the bid on behalf of (name of the bidder) as evidenced by the attached (state the written authority).

We acknowledge that failure to sign each and every page of this Bid Form, including the attached Schedule of prices, shall be a ground for the rejection of our bid.

Name: \_\_\_\_\_

Legal capacity: \_\_\_\_\_

Signature: \_\_\_\_\_

Duly authorized to sign the Bid for and behalf of \_\_\_\_\_

Date: \_\_\_\_\_



**Price Schedule for Goods Offered from Within the Philippines**  
*[shall be submitted with the Bid if bidder is offering goods from within the Philippines]*

**For Goods Offered from Within the Philippines**

Name of Bidder \_\_\_\_\_ Project ID No. \_\_\_\_\_ Page \_\_\_\_ of \_\_\_\_

| 1    | 2           | 3                 | 4        | 5                       | 6   | 7  | 8  | 9                                      | 10   |
|------|-------------|-------------------|----------|-------------------------|---|--|--|--|--|
| Item | Description | Country of origin | Quantity | Unit price EXW per item | Transportation and all other costs incidental to delivery, per item | Sales and other taxes payable if Contract is awarded, per item | Cost of Incidental Services, if applicable, per item | Total Price, per unit<br>(col 5+6+7+8) | Total Price delivered Final Destination<br>(col 9) x (col 4) |
|      |             |                   |          |                         |   |  |  |  |  |

Name: \_\_\_\_\_

Legal Capacity: \_\_\_\_\_

Signature: \_\_\_\_\_

Duly authorized to sign the Bid for and behalf of: \_\_\_\_\_

## ANNEX “E”

### STATEMENT OF ALL ONGOING GOVERNMENT AND PRIVATE CONTRACTS INCLUDING CONTRACTS AWARDED BUT NOT YET STARTED

NAME OF CONTRACT TO BE BID: CORRUGATED CARTON FOR SAN PABLO MANUFACTURING CORPORATION

This is to certify that \_\_\_\_\_ has the following ongoing government and private contracts including contracts awarded but not yet started within the last five (5) years:

| Name of the Contract | Date of the Contract | Contract Duration | Owner’s Name & Address | Kind of Goods | Amount of Contract | Value of Outstanding Contract | Date of Delivery |
|----------------------|----------------------|-------------------|------------------------|---------------|--------------------|-------------------------------|------------------|
| I. GOVERNMENT        |                      |                   |                        |               |                    |                               |                  |
|                      |                      |                   |                        |               |                    |                               |                  |
| II. PRIVATE          |                      |                   |                        |               |                    |                               |                  |
|                      |                      |                   |                        |               |                    |                               |                  |

**INSTRUCTIONS:**

- a.) State all ongoing contracts including those awarded but not yet started (government and private contracts which may be similar to the project called for bidding) as of the day before the deadline of submission and opening of bids.
- b.) If there is no ongoing contract including awarded but not yet started as of the aforementioned period, state none or equivalent term.
- c.) The total amount of the ongoing and awarded but not yet started contracts should be consistent with those used in the Net Financial Contracting Capacity (NFCC) in case an NFCC is submitted as an eligibility document.

Note: The supporting documents stated below shall be presented during the post-qualification. Failure to comply shall be grounds for the disqualification of the bidder:

- 1.) Notice of Award;
- 2.) Notice to Proceed; and
- 3.) Other supporting documents

**CERTIFIED CORRECT:**

\_\_\_\_\_  
Name & Signature of Authorized Representative

\_\_\_\_\_  
Position

\_\_\_\_\_  
Date

**ANNEX “F”**

**STATEMENT OF THE BIDDER’S SINGLE LARGEST COMPLETED CONTRACT (SLCC)**

NAME OF CONTRACT TO BE BID: CORRUGATED CARTON FOR SAN PABLO MANUFACTURING CORPORATION

This is to certify that \_\_\_\_\_ has the following Single Largest Completed Contract (SLCC) similar to the contract to be bid equivalent to at least Fifty Percent (50%) of the Approved Budget to the Contract (ABC) within the last five (5) years:

| Name of Contract | Date of Contract | Duration of Contract | Owner’s Name and Address | Kinds of Goods | Amount of Completed Contract | Date of Delivery | End User’s Acceptance or Official Receipt(s) or Sales Invoice (If completed) |
|------------------|------------------|----------------------|--------------------------|----------------|------------------------------|------------------|--|
|                  |                  |                      |                          |                |                              |                  |  |

- Instructions:
- a.) Cut-off date: The day before the deadline of submission and opening of bids.
  - b.) In the column for “End-user’s Acceptance”, indicate the date of acceptance or Official Receipt(s) or Sales Invoice.

Note: The supporting documents stated below shall be presented during the post-qualification. Failure to comply shall be grounds for the disqualification of the bidder.

- 1) Contract or Purchase Order;
- 2) Sales Invoice; and
- 3) Certificate of Performance/Acceptance

CERTIFIED CORRECT:

\_\_\_\_\_  
Name & Signature of Authorized Representative

\_\_\_\_\_  
Position

\_\_\_\_\_  
Date

**Contract Agreement Form for the Procurement of Goods (Revised)**

*[Not required to be submitted with the Bid, but it shall be submitted within ten (10) days after receiving the Notice of Award]*

**CONTRACT AGREEMENT**

THIS AGREEMENT made the \_\_\_\_\_ day of \_\_\_\_\_ 20\_\_ between [name of PROCURING ENTITY] of the Philippines (hereinafter called "the Entity") of the one part and [name of Supplier] of [city and country of Supplier] (hereinafter called "the Supplier") of the other part;

WHEREAS, the Entity invited Bids for certain goods and ancillary services, particularly [brief description of goods and services] and has accepted a Bid by the Supplier for the supply of those goods and services in the sum of *[contract price in words and figures in specified currency]* (hereinafter called "the Contract Price").

NOW THIS AGREEMENT WITNESSETH AS FOLLOWS:

1. In this Agreement words and expressions shall have the same meanings as are respectively assigned to them in the Conditions of Contract referred to.
2. The following documents as required by the 2016 revised Implementing Rules and Regulations of Republic Act No. 9184 shall be deemed to form and be read and construed as integral part of this Agreement, viz.:
  - i. Philippine Bidding Documents (PBDs);
    - i. Schedule of Requirements;
    - ii. Technical Specifications;
    - iii. General and Special Conditions of Contract; and
    - iv. Supplemental or Bid Bulletins, if any
  - ii. Winning bidder's bid, including the Eligibility requirements, Technical and Financial Proposals, and all other documents or statements submitted;
 

Bid form, including all the documents/statements contained in the Bidder's bidding envelopes, as annexes, and all other documents submitted (e.g., Bidder's response to request for clarifications on the bid), including corrections to the bid, if any, resulting from the Procuring Entity's bid evaluation;
  - iii. Performance Security;
  - iv. Notice of Award of Contract; and the Bidder's conforme thereto; and
  - v. Other contract documents that may be required by existing laws and/or the Procuring Entity concerned in the PBDs. **Winning bidder agrees that additional contract documents or information prescribed by the GPPB that are subsequently required for submission after the contract execution, such as the Notice to Proceed, Variation Orders, and Warranty Security, shall likewise form part of the Contract.**

3. In consideration for the sum of *[total contract price in words and figures]* or such other sums as may be ascertained, *[Named of the bidder]* agrees to *[state the object of the contract]* in accordance with his/her/its Bid.
4. The *[Name of the procuring entity]* agrees to pay the above-mentioned sum in accordance with the terms of the Bidding.

IN WITNESS whereof the parties hereto have caused this Agreement to be executed in accordance with the laws of the Republic of the Philippines on the day and year first above written.

*[Insert Name and Signature]*

*[Insert Name and Signature]*

*[Insert Signatory's Legal Capacity]*

*[Insert Signatory's Legal Capacity]*

for:

for:

*[Insert Procuring Entity]*

*[Insert Name of Supplier]*

### **Acknowledgment**

*[Format shall be based on the latest Rules on Notarial Practice]*

## ANNEX "H"

### COMPUTATION OF NET FINANCIAL CONTRACTING CAPACITY

The bidder must submit a computation of its Net Financial Contracting Capacity (NFCC), which must be at least equal to the ABC to be bid, calculated as follows:

**NFCC** = [(Current asset minus current liabilities) (15)] minus the value of all outstanding or uncompleted portions of the projects under ongoing contracts, including awarded contracts yet to be started coinciding with the contract to be bid.

The values of the domestic bidder's current assets and current liabilities shall be based on the latest Audited Financial Statements submitted to the BIR.

|                                       | Amount |
|---------------------------------------|--------|
| Current Assets                        |        |
| Minus: Current Liabilities            |        |
| Sub-Total                             |        |
| Multiplied by 15                      |        |
| Sub-Total                             |        |
| Minus: Value of Outstanding Contracts |        |
| <b>NFCC</b>                           |        |

Submitted By:

\_\_\_\_\_  
Name of the Supplier / Distributor / Manufacturer

\_\_\_\_\_  
Signature of Authorized Representative

REPUBLIC OF THE  
PHILIPPINES) CITY OF \_\_\_\_\_) S.S.

**SWORN CERTIFICATION / AFFIDAVIT OF COMPLIANCE WITH  
THE TECHNICAL SPECIFICATIONS  
RE: VARIOUS CORRUGATED CARTONS FOR SAN PABLO  
MANUFACTURING CORPORATION**

I, [NAME OF BIDDER’S AUTHORIZED REPRESENTATIVE], Filipino, of legal age, with address at [BIDDER’S ADDRESS], after having been duly sworn in accordance with law, depose and state:

1. I am the President/Chief Executive Officer of [NAME OF BIDDER]. I have been duly authorized by the [NAME OF BIDDER]’s Board of Directors to execute this *Sworn Certification* on behalf of [NAME OF BIDDER], as shown by the secretary’s certificate attesting to the board resolution that is attached hereto as **Annex “I”**.
2. In connection with the [NAME OF BIDDER]’s bid for the “*2nd Public Bidding for the Procurement of Various Corrugated Cartons for San Pablo Manufacturing Corporation (SPMC-2023- 009B)*” (“Project”), I hereby attest on behalf of [NAME OF BIDDER] that:
  - 2.1. [NAME OF BIDDER] represents and warrants that the RBD Palm Olein for San Pablo Manufacturing Corporation to be supplied by [NAME OF BIDDER] complies with the specifications under the Philippine Bidding Documents.
  - 2.2 [NAME OF BIDDER] recognizes and accepts that compliance with the representation and/or warranty expressed in Clause 2.1 of this *Sworn Certification* is a continuing requirement. Should it be awarded the Contract for the Project, [NAME OF BIDDER] binds itself that it shall continue to comply with the said representation and/or warranty until the [NAME OF BIDDER] has completely delivered to San Pablo Manufacturing Corporation the Corrugated Cartons being contemplated by the Philippine Bidding Documents;
  - 2.3 [NAME OF BIDDER] shall strictly comply with terms of the Philippine Bidding Documents and the

corresponding Bid Bulletins that may be issued in connection therewith;

2.4 Without prejudice to the other remedies that are available to **SAN PABLO MANUFACTURING CORPORATION**, [NAME OF BIDDER] unconditionally accepts that its failure to comply with any of the undertakings mentioned herein, or the falsity of the information provided above, will result in the forfeiture of its bid security/performance bond in favor of **SAN PABLO MANUFACTURING CORPORATION**; and

2.5 [NAME OF BIDDER] represents and warrants that all the foregoing information are true and correct. Any falsity, error, or misrepresentation shall automatically disqualify [NAME OF BIDDER] from being awarded the Contract for the Project

3. I am executing this *Sworn Certification/Affidavit of Compliance with the Technical Specifications* to attest to the truth of the foregoing.

IN WITNESS WHEREOF, I have hereunto set my hand this \_\_\_ day of \_\_\_\_\_ 2022 in \_\_\_\_\_.

[NAME OF BIDDER'S  
AUTHORIZED REPRESENTATIVE],  
*Affiant*

SUBSCRIBED AND SWORN to before me this \_\_ day of \_\_\_\_\_ 2022 in \_\_\_\_\_, affiant, who is personally known to me, exhibiting to me the following:

| Affiant  | Competent Evidence of Identity |                           |
|--|--------------------------------|---------------------------|
|  | Type of ID                     | ID Number and Expiry Date |
| NAME OF BIDDER'S<br>AUTHORIZED<br>REPRESENTATIVE], |                                |                           |

Doc. No. \_\_\_\_\_;  
Page No. \_\_\_\_\_;  
Book No. \_\_\_\_\_;  
Series of 2022.



## *Section X. Appendix*

**Annex “J”**

Sealing of Bids as defined in Section 15 of the ITB  
(Illustration of bids with 1 original, 1 duplicate and 1 USB copy, each box in the diagram represents a sealed envelope)

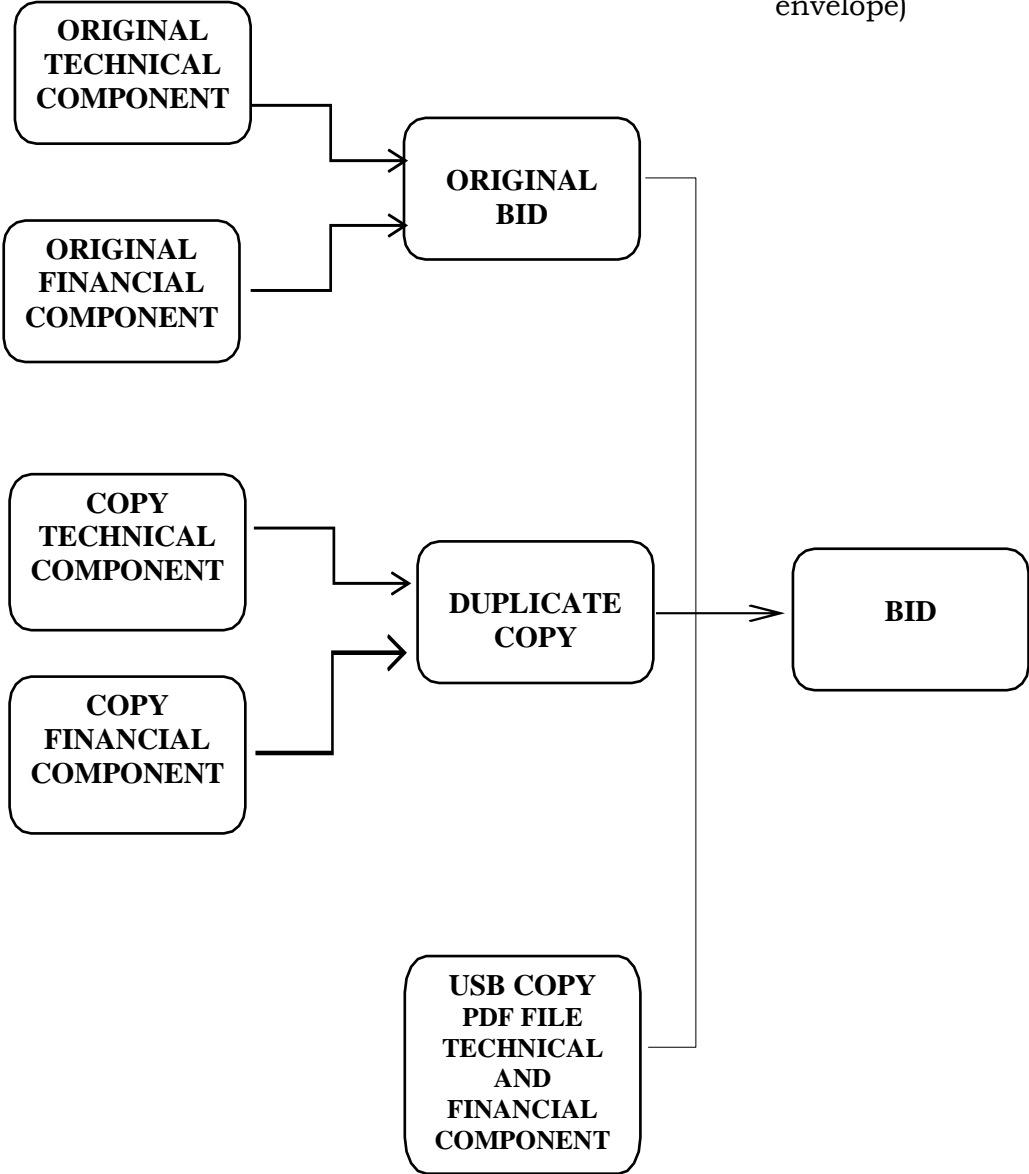

1. Mechanical Drawing / Factory Card for Minola Corrugated Carton for PE 4 x 3.5Liter

|   |   |  |               |
|---|---|--|---------------|
| <b>CUSTOMER :</b> SAN PABLO MFG. CORP.<br><b>MODEL :</b> MINOLA PE - 4 X 3.5 LITERS | <b>DIMENSIONS</b><br>MM OD 408 x 278 x 314 (+/-3)<br>MM ID 405 x 275 x 308 (+/-3)<br><b>TEST:</b> 175 # <b>FLUTE:</b> B | <b>COLORS</b><br>YELLOW    RED    GREEN    CODE<br>JOINT: GLUED IN    BOX COLOR: BROWN    STYLE: RSC | MINOLA-045A-1 |
|---|---|--|---------------|

**"Minolakas, Minolasap, Minolauric"**  
**4 x 3.5 Liters**

Cholesterol Free Food

HALAL

2013-F-616-01

FORTIFIED

**minola**  
PREMIUM COCONUT OIL  
LAURIC OIL

3.5 Liters

Member:

CIIF OIL MILLS GROUP  
Visit us at [www.ciif.ph](http://www.ciif.ph)

1 48 00094 03266 5

**BUY PINDY**  
BUY LOCAL

**INGREDIENTS:**  
100% Pure Coconut Oil and Vitamin A Palmitate (Fortificant)

**IMPORTANT:** PLEASE CHECK THOROUGHLY THE SIZES, SPELLINGS, TEXT ARRANGEMENT, LOGO, AND STYLE FOR THIS ARTWORK BEFORE APPROVING IT. PRINTER INK MAY NOT MATCH ACTUAL COLOR. PLEASE REFER TO APPROVED ISO/COLOR GUIDE/ DIMENSION/PRINT DISTANCE TOLERANCE REFER TO REFERENCE RF-PDD-002

|                                 |                 |   |                                |                          |             |                  |   |
|---------------------------------|-----------------|---|--------------------------------|--------------------------|-------------|------------------|---|
| DATE PREPARED :<br>OCT. 10-2018 | REV. NO.<br>001 | REMARKS<br>01-50 years to 60 years logo | BARCODE Nos.<br>14800094032665 | DRAWN BY:<br>Ara Sherryl | CHECKED BY: | CUSTOMER SERVICE | CUSTOMER'S APPROVAL<br>Approved By:<br>Date Approved: |
|---------------------------------|-----------------|---|--------------------------------|--------------------------|-------------|------------------|---|

for: 01 3-04-2020

Partition for Minola 4 x 3.5 liter

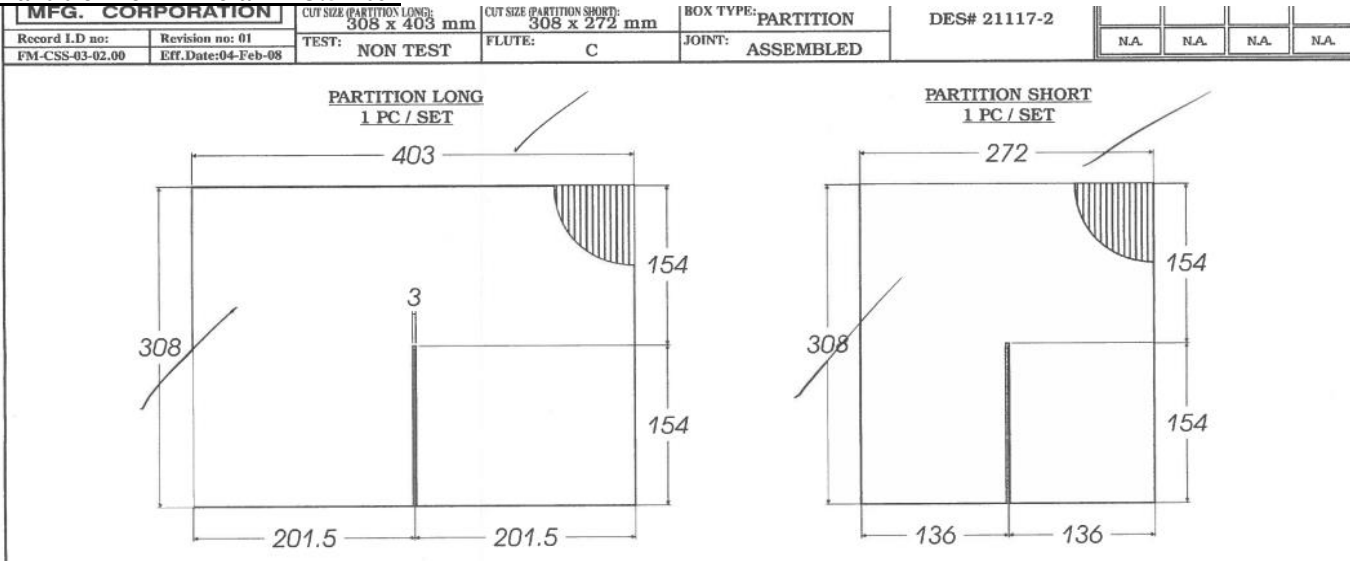

# Annex "K-2"

## 2. Mechanical Drawing / Factory Card for Minola Corrugated Carton for PE 10 x 1.75Liter

TW = 581mm

165

251

165

**TL = 1768mm**

35      538      330      538      327

**COMBINATION:**

OL: \_\_\_\_\_

BM: \_\_\_\_\_

BL: \_\_\_\_\_

CM: \_\_\_\_\_

CL: \_\_\_\_\_

EM: \_\_\_\_\_

EL: \_\_\_\_\_

**PRICE:**

\_\_\_\_\_

**MACHINE:**

1 \_\_\_\_\_

2 \_\_\_\_\_

3 \_\_\_\_\_

**REMARKS:**

REQUIREMENTS:

SURSTING: \_\_\_\_\_

BCT: \_\_\_\_\_

TOLERANCE:

L \_\_\_\_\_ W \_\_\_\_\_ H \_\_\_\_\_

JOINT GAP: \_\_\_\_\_

FLAP GAP: \_\_\_\_\_

**TRIPLE STAR PACKAGING CORP.**

**175 lbs./inch**

**P.O. NO.:** \_\_\_\_\_

**PROD'N. DATE:** \_\_\_\_\_

**ITEM CODE**

● ● ●

**NOTE : SEE ENLARGEMENT ON PAGE 2..**

|  |  |                    |  |            |            |       |     |            |            |            |            |        |     |       |     |                                  |  |  |  |                    |
|--|--|--------------------|--|------------|------------|-------|-----|------------|------------|------------|------------|--------|-----|-------|-----|----------------------------------|--|--|--|--------------------|
| <p>MACHINE DIRECTION</p>   | <b>CUSTOMER</b> SAN PABLO MFG. CORPORATION | <b>BOARD SIZE</b>  | <table border="1" style="width: 100%; border-collapse: collapse;"> <tr> <td style="background-color: yellow;">YELLOW</td> <td style="background-color: red;">RED</td> <td style="background-color: green;">GREEN</td> <td style="background-color: white;">XXX</td> </tr> <tr> <td style="font-size: 8px;">COLOR CODE</td> <td style="font-size: 8px;">COLOR CODE</td> <td style="font-size: 8px;">COLOR CODE</td> <td style="font-size: 8px;">COLOR CODE</td> </tr> <tr> <td style="font-size: 8px;">YELLOW</td> <td style="font-size: 8px;">RED</td> <td style="font-size: 8px;">GREEN</td> <td style="font-size: 8px;">XXX</td> </tr> <tr> <td colspan="4" style="font-size: 8px; text-align: center;">ALWAYS TAKE THE APPIAL FOR AD ON</td> </tr> </table> | YELLOW     | RED        | GREEN | XXX | COLOR CODE | COLOR CODE | COLOR CODE | COLOR CODE | YELLOW | RED | GREEN | XXX | ALWAYS TAKE THE APPIAL FOR AD ON |  |  |  | <b>ACCESSORIES</b> |
|  | YELLOW                                     | RED                |  | GREEN      | XXX        |       |     |            |            |            |            |        |     |       |     |                                  |  |  |  |                    |
|  | COLOR CODE                                 | COLOR CODE         |  | COLOR CODE | COLOR CODE |       |     |            |            |            |            |        |     |       |     |                                  |  |  |  |                    |
|  | YELLOW                                     | RED                |  | GREEN      | XXX        |       |     |            |            |            |            |        |     |       |     |                                  |  |  |  |                    |
| ALWAYS TAKE THE APPIAL FOR AD ON   |  |                    |  |            |            |       |     |            |            |            |            |        |     |       |     |                                  |  |  |  |                    |
| <b>BRAND</b> MINOLA - PE 10 X 1.75 LITER   | <b>JOINT</b> GLUED                         | <p><b>NONE</b></p> |  |            |            |       |     |            |            |            |            |        |     |       |     |                                  |  |  |  |                    |
| <b>SIZE (LxWxH)</b> 535 mm x 327 mm x 245 mm I.D.<br>538 mm x 330 mm x 251 mm O.D. | <b>BARCODE NO.</b> 1 48 00094 03477 5      |                    |  |            |            |       |     |            |            |            |            |        |     |       |     |                                  |  |  |  |                    |
| <b>BOX STYLE</b> RSC   | <b>FLUTE / TEST</b> B / 175 LBS.           |                    |  |            |            |       |     |            |            |            |            |        |     |       |     |                                  |  |  |  |                    |

### Partition for Minola 10 x 1.75 Liter

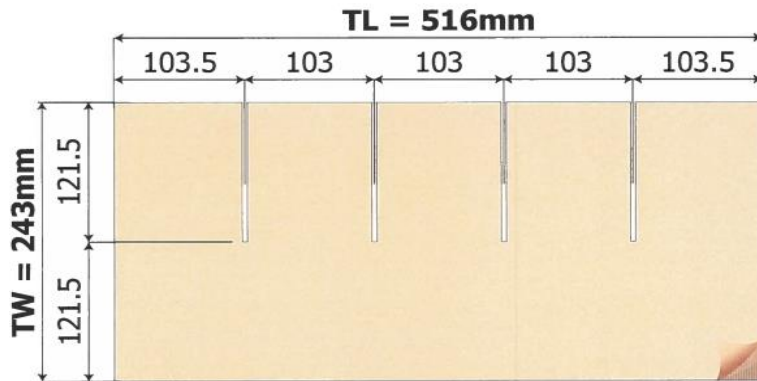

**PARTITION LONG 1PC.**

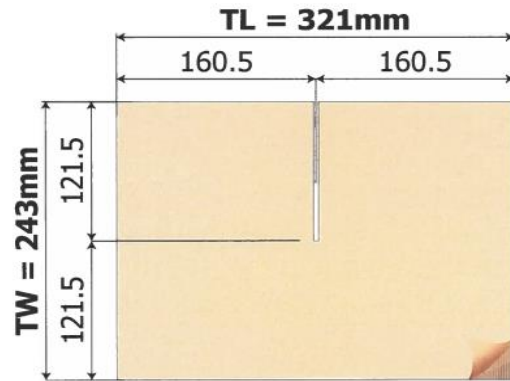

**PARTITION SHORT 4PCS.**

# Annex "K-3"

## 3. Mechanical Drawing / Factory Card for Corrugated Carton for All Purpose Shortening 20K

TW = 504mm

TL = 1499mm

|  |  |   |  |   |
|--|--|---|--|---|
|  | DO NOT STACK OVER 8 HIGH   | HANDLE WITH CARE<br>THIS SIDE UP  |  |   |
|  | <br><b>ALL-PURPOSE SHORTENING</b><br><small>BEST FOR BAKING • FRYING • COOKING</small> | <small>NET WEIGHT: 20 KGS.</small><br><br><small>INGREDIENTS:<br/>Refined Bleached Decolorized, Coconut Oil,<br/>Fully Hydrogenated Palm Stearin.</small> | <br><b>ALL-PURPOSE SHORTENING</b><br><small>BEST FOR BAKING • FRYING • COOKING</small> | <small>NET WEIGHT: 20 KGS.</small><br><br><small>CIIF OIL MILLS GROUP<br/>Visit us at www.ciif.ph</small> |
|  |  |   |  |   |

**Premium Quality**

  
2013-F-616-03

NET WEIGHT: 20 KGS.

Member:

CIIF OIL MILLS GROUP  
Visit us at [www.ciif.ph](http://www.ciif.ph)  
Manufactured by:  
SAN PABLO MANUFACTURING CORPORATION  
CAIP SEZ Brgy. San Antonio, San Pascual,  
Batangas 4204, Philippines

**SPMC**  
SAN PABLO MANUFACTURING CORP  
Makers of *minola* Premium Coconut Oil

**ALL-PURPOSE SHORTENING**  
BEST FOR BAKING • FRYING • COOKING

FLAP GAP: \_\_\_\_\_

OTHERS: \_\_\_\_\_

**NOTE: NO SAMPLE BOX**

|                              |              |                                      |                 |                                   |             |                    |
|------------------------------|--------------|--------------------------------------|-----------------|-----------------------------------|-------------|--------------------|
| <br><b>MACHINE DIRECTION</b> | CUSTOMER     | <b>SAN PABLO MANUFACTURING CORP.</b> |                 | BOARD SIZE                        |             |                    |
|                              | B R A N D    | <b>ALL PURPOSE SHORTENING 20kgs.</b> |                 | <b>504 mm (TW) X 1499 mm (TL)</b> |             |                    |
|                              | SIZE (LxWxH) | <b>464 mm X</b>                      | <b>268 mm X</b> | <b>230 mm</b>                     | <b>O.D.</b> | JOINT <b>GLUED</b> |
|                              | BOX STYLE    | <b>RSC</b>                           | FLUTE / TEST    | <b>BC / 350 LBS.</b>              | BARCODE NO. | <b>NONE</b>        |

COLOR CODE  
**RED**

COLOR CODE  
**GREEN**

COLOR CODE  
**BROWN**













COLOR CODE  
**BLACK**

**ACCESSORIES**

NONE

# Annex “K-4”

## 4. Mechanical Drawing / Factory Card for Corrugated Carton for Butter Flavored Margarine 20K

|   |   |   |   |  |  |  |     |
|---|---|---|---|--|--|--|-----|
| <b>TL = 1448mm</b>  |   |   |   |  |  <p><b>NET WEIGHT:</b></p> <p><b>BUTTER-FLAVORED MARGARINE</b></p> <p>BEST FOR BAKING • FRYING • COOKING</p> <p>Member:</p>  <p><b>CIIF OIL MILLS GROUP</b></p> <p>Visit us at <a href="http://www.ciif.ph">www.ciif.ph</a></p> <p>Manufactured by:<br/>SAN PABLO MANUFACTURING CORPORATION<br/>CAIP SEZ Brgy. San Antonio, San Pascual,<br/>Batangas 4204, Philippines</p> | <b>COMBINATION:</b>  |     |
| 35  | 368   | 339   | 369   | 337  |  | OL: _____<br>BM: _____<br>BL: _____<br>CM: _____<br>CL: _____<br>EM: _____<br>EL: _____  |     |
| 172<br>254<br>172   | DO NOT STACK OVER 5 HIGH<br><br> <p><b>BUTTER-FLAVORED MARGARINE</b></p> <p>BEST FOR BAKING • FRYING • COOKING</p> |  <p><b>NET WEIGHT:</b></p> <p><b>INGREDIENTS:</b><br/>Refined bleached deodorized Coconut Oil,<br/>Palm Stearin, Water, Salt, Skimmed Milk Powder,<br/>Distilled Monoglyceride (emulsifier), Butter Flavor,<br/>Potassium Sorbate (Preservative), Citric Acid,<br/>Hydroxytoluene (Antioxidant), B-carotene (Colorant).</p> <p><i>For Allergen Information:</i><br/>Contains: Skimmed Milk Powder and Lecithin (Soya).</p> | THIS SIDE UP<br>HANDLE WITH CARE<br><br> <p><b>BUTTER-FLAVORED MARGARINE</b></p> <p>BEST FOR BAKING • FRYING • COOKING</p> |  <p><b>NET WEIGHT:</b></p> <p><b>CIIF OIL MILLS GROUP</b></p> <p>Visit us at <a href="http://www.ciif.ph">www.ciif.ph</a></p> <p>Manufactured by:<br/>SAN PABLO MANUFACTURING CORPORATION<br/>CAIP SEZ Brgy. San Antonio, San Pascual,<br/>Batangas 4204, Philippines</p> |  | <b>MACHINE:</b><br>1 _____<br>2 _____<br>3 _____   |     |
| <b>INGREDIENTS:</b><br>Refined bleached deodorized Coconut Oil,<br>Palm Stearin, Water, Salt, Skimmed Milk Powder,<br>Distilled Monoglyceride (emulsifier), Butter Flavor,<br>Potassium Sorbate (Preservative), Citric Acid<br>(Acidity Regulator), Soy Lecithin (Emulsifier), Butylated<br>Hydroxytoluene (Antioxidant), B-carotene (Colorant).  |   |   |   |  |  | <b>REMARKS:</b><br><br>REQUIREMENTS:<br>BURSTING: _____<br>BCT : _____<br><br>TOLERANCE:<br>L _____ W _____ H _____<br><br>JOINT GAP: _____<br>FLAP GAP: _____ |     |
|  <p><b>DO NOT STACK OVER 5 HIGH</b><br/><b>THIS SIDE UP</b><br/><b>HANDLE WITH CARE</b></p>    <p>2013-F-618-05</p> |   |   |   |  | Member:<br> <p><b>CIIF OIL MILLS GROUP</b></p> <p>Visit us at <a href="http://www.ciif.ph">www.ciif.ph</a></p> <p>Manufactured by:<br/>SAN PABLO MANUFACTURING CORPORATION<br/>CAIP SEZ Brgy. San Antonio, San Pascual,<br/>Batangas 4204, Philippines</p>  |  |     |
| <b>NOTE:</b>  |   |   |   |  |  |  |     |
| <br>MACHINE DIRECTION  | <b>CUSTOMER</b>   | SAN PABLO MFG. CORP.  |   | <b>BOARD SIZE</b>  |  | <b>ACCESSORIES</b><br><br><div style="font-size: 2em; font-weight: bold; text-align: center;">NONE</div>   |     |
|   | <b>BRAND</b>  | MINOLA MTH / MBM 20K  |   | <b>598 mm (TW) x 1448 mm (TL)</b>  |  |  |     |
|   | <b>SIZE (LxWxH)</b>   | xxx mm x xxx mm x xxx mm I.D.<br>369 mm x 339 mm x 254 mm O.D.  |   | <b>JOINT</b>   | <b>GLUED</b>   |  |     |
|   | <b>BOX STYLE</b>  | RSC   | <b>FLUTE / TEST</b>   | BC / 51 ECT  | <b>BARCODE NO.</b>   |  | N/A |
|   |   |   |   |  <p>ALWAYS BASE THE APPIAL PAIAB AN</p>  |  |  |     |







